

Price list 2023 / 02



Segmented fittings

PAGES. 5-17



Electrofusion fittings

PAGES. 18-26



Injection fittings

PAGES. 27-39



Steel Flange

PAGES. 40



Couplings WAGA MJ 3000 PLUS

PAGE. 41

Fabricated elbows (bends)

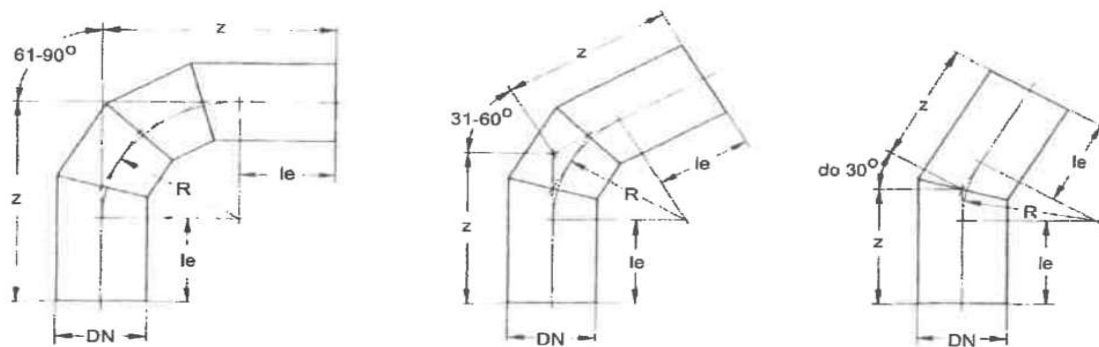

le min. (to PN-EN 12201-3)						
DN [mm]	90	250	315	500	900	
	110					
	125					
	140					
	160					
	180					
	200					
	225					
	250					350
	le [mm]					150

Fabricated tee

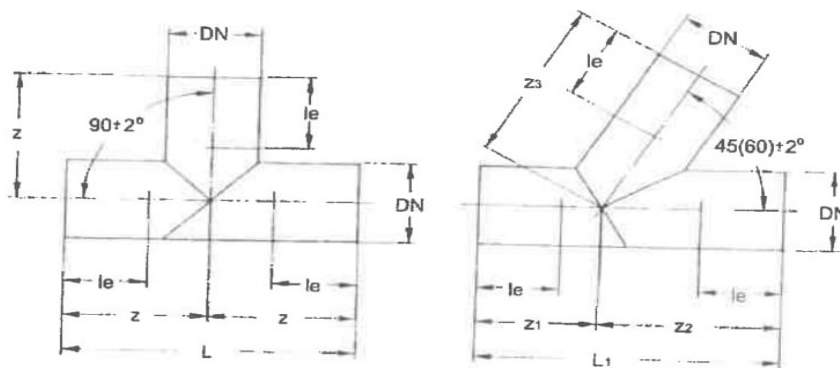

Polish Standard does not provide for lengths of tapping saddles z , z_1 , z_2 and z_3 , making fitting manufacturers responsible for defining them in technical documentations. This means that bend radius R is not defined precisely and depends on fitting's manufacturer (or agreements applicable for the ordered elbows).

Fabricated fittings are made in workshop conditions by butt welding of polypropylene pipe sections. The most important advantages of such solutions are: ability to deliver elbows with any angle required for construction of pipeline, ability to deliver fittings for large diameters (when no fittings made with injection method are available) and relatively low price.

Pressure reduction factors

According to PN-EN 12201-3, the nominal pressure reduction factors must be used for fabricated fittings in comparison with nominal pressure of pipe they are made of. These factors depend on structure of the fitting section.

- for elbows (bends):

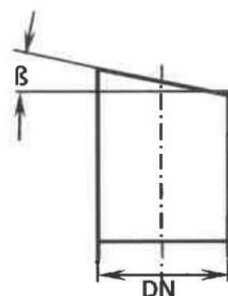

Where:

DN - nominal outside diameter;

β - cutting angle for the fitting section ($\beta \leq 15^\circ$)

Reduction factors for fabricated pipe bends (elbows)	
Cutting angle β	Pressure reduction factor f_B
$\leq 7.5^\circ$	1.0
$7.5^\circ < \beta \leq 15^\circ$	0.8

- for tee pieces factor $f_B = 0.6$

Sample cutting angle for the fitting section β								
Elbow	90°	75°	67°	60°	45°	30°	22°	15°
β	15°	12.5°	11.20°	15°	11.25°	15°	11°	7.5°



To provide compliance of nominal pressure between the fitting and pipe, it is possible to increase gauge (reduce SDR) of the pipe used to produce the fitting. Fittings are made in such way that their gauge corresponds with the pipe gauge in the place of welding. In order to receive such fabricated fittings, the requirement must be clearly stated in the purchase order (or letter of inquiry).

In case of fabricated elbows, it is possible to obtain compatibility between nominal pressure of the pipe and fittings by use of elbows made with cutting angle $\leq 7.5^\circ$. It involves a larger number of sections used to make such elbows.

Fittings dimensions

According to Polish Standard PN-EN 12201-3, the tolerance for fabricated fitting cutting angle is $\pm 2^\circ$. The length of pipe section of the fitting pipe spigot should enable application of clamps during butt welding, installation with a fitting made by electric resistance welding, installation with a fitting made by welding and application of mechanical coarse file.

Segmented elbow full pressure PE100 SDR 11, SDR 17 0-15°

SDR11			SDR17		
d	Code	Price Net	Code	Price Net	
90	Sew-K-100/11-090/*	14,08 €	Sew-K-100/17-090/*	11,88 €	  
110	Sew-K-100/11-110/*	20,02 €	Sew-K-100/17-110/*	16,50 €	
125	Sew-K-100/11-125/*	25,30 €	Sew-K-100/17-125/*	20,68 €	
140	Sew-K-100/11-140/*	31,02 €	Sew-K-100/17-140/*	24,86 €	
160	Sew-K-100/11-160/*	38,72 €	Sew-K-100/17-160/*	30,36 €	
180	Sew-K-100/11-180/*	46,64 €	Sew-K-100/17-180/*	36,08 €	
200	Sew-K-100/11-200/*	60,50 €	Sew-K-100/17-200/*	46,20 €	
225	Sew-K-100/11-225/*	73,48 €	Sew-K-100/17-225/*	55,44 €	
250	Sew-K-100/11-250/*	105,16 €	Sew-K-100/17-250/*	77,22 €	
280	Sew-K-100/11-280/*	137,94 €	Sew-K-100/17-280/*	100,54 €	
315	Sew-K-100/11-315/*	185,24 €	Sew-K-100/17-315/*	133,54 €	
355	Sew-K-100/11-355/*	260,92 €	Sew-K-100/17-355/*	189,42 €	
400	Sew-K-100/11-400/*	332,86 €	Sew-K-100/17-400/*	238,70 €	
450	Sew-K-100/11-450/*	493,90 €	Sew-K-100/17-450/*	360,80 €	
500	Sew-K-100/11-500/*	707,08 €	Sew-K-100/17-500/*	507,76 €	
560	Sew-K-100/11-560/*	913,88 €	Sew-K-100/17-560/*	650,98 €	
630	Sew-K-100/11-630/*	1 247,18 €	Sew-K-100/17-630/*	880,66 €	
710	Sew-K-100/11-710/*	1 831,72 €	Sew-K-100/17-710/*	1 301,30 €	
800	Sew-K-100/11-800/*	2 502,06 €	Sew-K-100/17-800/*	1 775,62 €	
900	Sew-K-100/11-900/*	on request	Sew-K-100/17-900/*	on request	
1000	Sew-K-100/11-000/*	on request	Sew-K-100/17-000/*	on request	
1200	Sew-K-100/11-012/*	on request	Sew-K-100/17-012/*	on request	

* degree (f.e. 30 for degree 30°; 60 for degree 60°)

Segmented elbow full pressure PE100 SDR 11, SDR 17 16-30°

SDR11			SDR17		
d	Code	Price Net	Code	Price Net	
90	Sew-K-100/11-090/*	23,32 €	Sew-K-100/17-090/*	20,46 €	  
110	Sew-K-100/11-110/*	32,78 €	Sew-K-100/17-110/*	28,16 €	
125	Sew-K-100/11-125/*	41,36 €	Sew-K-100/17-125/*	34,98 €	
140	Sew-K-100/11-140/*	50,38 €	Sew-K-100/17-140/*	42,02 €	
160	Sew-K-100/11-160/*	61,38 €	Sew-K-100/17-160/*	49,94 €	
180	Sew-K-100/11-180/*	77,22 €	Sew-K-100/17-180/*	61,16 €	
200	Sew-K-100/11-200/*	97,90 €	Sew-K-100/17-200/*	76,56 €	
225	Sew-K-100/11-225/*	122,98 €	Sew-K-100/17-225/*	94,38 €	
250	Sew-K-100/11-250/*	165,44 €	Sew-K-100/17-250/*	124,30 €	
280	Sew-K-100/11-280/*	215,82 €	Sew-K-100/17-280/*	160,38 €	
315	Sew-K-100/11-315/*	282,48 €	Sew-K-100/17-315/*	207,46 €	
355	Sew-K-100/11-355/*	390,72 €	Sew-K-100/17-355/*	289,74 €	
400	Sew-K-100/11-400/*	503,58 €	Sew-K-100/17-400/*	367,62 €	
450	Sew-K-100/11-450/*	771,54 €	Sew-K-100/17-450/*	575,52 €	
500	Sew-K-100/11-500/*	1 062,82 €	Sew-K-100/17-500/*	777,48 €	
560	Sew-K-100/11-560/*	1 420,10 €	Sew-K-100/17-560/*	1 025,64 €	
630	Sew-K-100/11-630/*	1 874,40 €	Sew-K-100/17-630/*	1 341,56 €	
710	Sew-K-100/11-710/*	3 007,40 €	Sew-K-100/17-710/*	2 158,64 €	
800	Sew-K-100/11-800/*	4 088,70 €	Sew-K-100/17-800/*	2 931,72 €	
900	Sew-K-100/11-900/*	on request	Sew-K-100/17-900/*	on request	
1000	Sew-K-100/11-000/*	on request	Sew-K-100/17-000/*	on request	
1200	Sew-K-100/11-012/*	on request	Sew-K-100/17-012/*	on request	

* degree (f.e. 30 for degree 30°; 60 for degree 60°)

Segmented elbow full pressure PE100 SDR 11, SDR 17 31-45°

SDR11			SDR17		
d	Code	Price Net	Code	Price Net	
90	Sew-K-100/11-090/*	32,56 €	Sew-K-100/17-090/*	29,04 €	  
110	Sew-K-100/11-110/*	45,32 €	Sew-K-100/17-110/*	39,60 €	
125	Sew-K-100/11-125/*	57,42 €	Sew-K-100/17-125/*	49,28 €	
140	Sew-K-100/11-140/*	69,74 €	Sew-K-100/17-140/*	58,96 €	
160	Sew-K-100/11-160/*	85,14 €	Sew-K-100/17-160/*	70,18 €	
180	Sew-K-100/11-180/*	105,82 €	Sew-K-100/17-180/*	85,14 €	
200	Sew-K-100/11-200/*	135,08 €	Sew-K-100/17-200/*	106,92 €	
225	Sew-K-100/11-225/*	169,62 €	Sew-K-100/17-225/*	131,56 €	
250	Sew-K-100/11-250/*	222,64 €	Sew-K-100/17-250/*	169,18 €	
280	Sew-K-100/11-280/*	289,52 €	Sew-K-100/17-280/*	217,36 €	
315	Sew-K-100/11-315/*	372,24 €	Sew-K-100/17-315/*	276,32 €	
355	Sew-K-100/11-355/*	523,82 €	Sew-K-100/17-355/*	392,48 €	
400	Sew-K-100/11-400/*	686,84 €	Sew-K-100/17-400/*	505,12 €	
450	Sew-K-100/11-450/*	1 038,84 €	Sew-K-100/17-450/*	782,98 €	
500	Sew-K-100/11-500/*	1 411,96 €	Sew-K-100/17-500/*	1 042,80 €	
560	Sew-K-100/11-560/*	1 885,62 €	Sew-K-100/17-560/*	1 372,80 €	
630	Sew-K-100/11-630/*	2 460,48 €	Sew-K-100/17-630/*	1 774,30 €	
710	Sew-K-100/11-710/*	4 117,30 €	Sew-K-100/17-710/*	2 971,76 €	
800	Sew-K-100/11-800/*	5 592,40 €	Sew-K-100/17-800/*	4 031,72 €	
900	Sew-K-100/11-900/*	on request	Sew-K-100/17-900/*	on request	
1000	Sew-K-100/11-000/*	on request	Sew-K-100/17-000/*	on request	
1200	Sew-K-100/11-012/*	on request	Sew-K-100/17-012/*	on request	

* degree (f.e. 30 for degree 30°; 60 for degree 60°)

Segmented elbow full pressure PE100 SDR 11, SDR 17 46-60°

SDR11			SDR17		
d	Code	Price Net	Code	Price Net	
90	Sew-K-100/11-090/*	42,68 €	Sew-K-100/17-090/*	38,06 €	  
110	Sew-K-100/11-110/*	58,74 €	Sew-K-100/17-110/*	51,48 €	
125	Sew-K-100/11-125/*	75,68 €	Sew-K-100/17-125/*	65,12 €	
140	Sew-K-100/11-140/*	90,42 €	Sew-K-100/17-140/*	76,78 €	
160	Sew-K-100/11-160/*	109,78 €	Sew-K-100/17-160/*	91,08 €	
180	Sew-K-100/11-180/*	135,52 €	Sew-K-100/17-180/*	109,78 €	
200	Sew-K-100/11-200/*	176,66 €	Sew-K-100/17-200/*	140,36 €	
225	Sew-K-100/11-225/*	216,26 €	Sew-K-100/17-225/*	168,74 €	
250	Sew-K-100/11-250/*	278,30 €	Sew-K-100/17-250/*	212,74 €	
280	Sew-K-100/11-280/*	367,40 €	Sew-K-100/17-280/*	277,20 €	
315	Sew-K-100/11-315/*	570,24 €	Sew-K-100/17-315/*	418,66 €	
355	Sew-K-100/11-355/*	765,16 €	Sew-K-100/17-355/*	568,70 €	
400	Sew-K-100/11-400/*	869,88 €	Sew-K-100/17-400/*	642,40 €	
450	Sew-K-100/11-450/*	1 332,32 €	Sew-K-100/17-450/*	1 008,26 €	
500	Sew-K-100/11-500/*	1 787,06 €	Sew-K-100/17-500/*	1 325,72 €	
560	Sew-K-100/11-560/*	2 350,92 €	Sew-K-100/17-560/*	1 719,96 €	
630	Sew-K-100/11-630/*	3 025,88 €	Sew-K-100/17-630/*	2 193,18 €	
710	Sew-K-100/11-710/*	5 358,76 €	Sew-K-100/17-710/*	3 873,54 €	
800	Sew-K-100/11-800/*	7 179,04 €	Sew-K-100/17-800/*	5 187,82 €	
900	Sew-K-100/11-900/*	on request	Sew-K-100/17-900/*	on request	
1000	Sew-K-100/11-000/*	on request	Sew-K-100/17-000/*	on request	
1200	Sew-K-100/11-012/*	on request	Sew-K-100/17-012/*	on request	

* degree (f.e. 30 for degree 30°; 60 for degree 60°)

KANALIZACJA 

Segmented elbow full pressure PE100 SDR 11, SDR 17 61-75°

SDR11			SDR17		
d	Code	Price Net	Code	Price Net	
90	Sew-K-100/11-090/*	52,58 €	Sew-K-100/17-090/*	47,08 €	  
110	Sew-K-100/11-110/*	71,94 €	Sew-K-100/17-110/*	63,58 €	
125	Sew-K-100/11-125/*	93,06 €	Sew-K-100/17-125/*	80,30 €	
140	Sew-K-100/11-140/*	110,22 €	Sew-K-100/17-140/*	94,16 €	
160	Sew-K-100/11-160/*	133,10 €	Sew-K-100/17-160/*	110,88 €	
180	Sew-K-100/11-180/*	165,00 €	Sew-K-100/17-180/*	134,42 €	
200	Sew-K-100/11-200/*	212,74 €	Sew-K-100/17-200/*	170,06 €	
225	Sew-K-100/11-225/*	260,26 €	Sew-K-100/17-225/*	203,94 €	
250	Sew-K-100/11-250/*	335,28 €	Sew-K-100/17-250/*	257,62 €	
280	Sew-K-100/11-280/*	441,10 €	Sew-K-100/17-280/*	334,18 €	
315	Sew-K-100/11-315/*	667,70 €	Sew-K-100/17-315/*	492,80 €	
355	Sew-K-100/11-355/*	894,96 €	Sew-K-100/17-355/*	669,02 €	
400	Sew-K-100/11-400/*	1 040,60 €	Sew-K-100/17-400/*	771,32 €	
450	Sew-K-100/11-450/*	1 599,40 €	Sew-K-100/17-450/*	1 215,72 €	
500	Sew-K-100/11-500/*	2 136,42 €	Sew-K-100/17-500/*	1 591,04 €	
560	Sew-K-100/11-560/*	2 816,44 €	Sew-K-100/17-560/*	2 067,34 €	
630	Sew-K-100/11-630/*	3 684,34 €	Sew-K-100/17-630/*	2 674,98 €	
710	Sew-K-100/11-710/*	6 468,66 €	Sew-K-100/17-710/*	4 686,66 €	
800	Sew-K-100/11-800/*	8 682,52 €	Sew-K-100/17-800/*	6 287,60 €	
900	Sew-K-100/11-900/*	on request	Sew-K-100/17-900/*	on request	
1000	Sew-K-100/11-000/*	on request	Sew-K-100/17-000/*	on request	
1200	Sew-K-100/11-012/*	on request	Sew-K-100/17-012/*	on request	

* degree (f.e. 30 for degree 30°; 60 for degree 60°)

Segmented elbow full pressure PE100 SDR 11, SDR 17 76-90°

SDR11			SDR17		
d	Code	Price Net	Code	Price Net	
90	Sew-K-100/11-090/*	62,26 €	Sew-K-100/17-090/*	55,88 €	  
110	Sew-K-100/11-110/*	85,36 €	Sew-K-100/17-110/*	75,46 €	
125	Sew-K-100/11-125/*	110,22 €	Sew-K-100/17-125/*	95,70 €	
140	Sew-K-100/11-140/*	130,24 €	Sew-K-100/17-140/*	111,54 €	
160	Sew-K-100/11-160/*	158,18 €	Sew-K-100/17-160/*	132,22 €	
180	Sew-K-100/11-180/*	194,70 €	Sew-K-100/17-180/*	158,84 €	
200	Sew-K-100/11-200/*	250,14 €	Sew-K-100/17-200/*	200,42 €	
225	Sew-K-100/11-225/*	308,22 €	Sew-K-100/17-225/*	242,00 €	
250	Sew-K-100/11-250/*	395,78 €	Sew-K-100/17-250/*	304,70 €	
280	Sew-K-100/11-280/*	515,02 €	Sew-K-100/17-280/*	391,16 €	
315	Sew-K-100/11-315/*	692,78 €	Sew-K-100/17-315/*	517,88 €	
355	Sew-K-100/11-355/*	933,02 €	Sew-K-100/17-355/*	707,08 €	
400	Sew-K-100/11-400/*	1 207,14 €	Sew-K-100/17-400/*	897,38 €	
450	Sew-K-100/11-450/*	1 866,70 €	Sew-K-100/17-450/*	1 423,18 €	
500	Sew-K-100/11-500/*	2 485,56 €	Sew-K-100/17-500/*	1 856,36 €	
560	Sew-K-100/11-560/*	3 281,96 €	Sew-K-100/17-560/*	2 414,50 €	
630	Sew-K-100/11-630/*	4 280,76 €	Sew-K-100/17-630/*	3 114,76 €	
710	Sew-K-100/11-710/*	7 578,78 €	Sew-K-100/17-710/*	5 499,56 €	
800	Sew-K-100/11-800/*	10 186,00 €	Sew-K-100/17-800/*	7 387,60 €	
900	Sew-K-100/11-900/*	on request	Sew-K-100/17-900/*	on request	
1000	Sew-K-100/11-000/*	on request	Sew-K-100/17-000/*	on request	
1200	Sew-K-100/11-012/*	on request	Sew-K-100/17-012/*	on request	

* degree (f.e. 30 for degree 30°; 60 for degree 60°)

Segmented elbow 0-30° PE100 SDR 11, SDR 17

Standard - pressure reduction factor 0,8

SDR11			SDR17		
d	Code	Price Net	Code	Price Net	
90	Sew-K-100/11-090/*	12,10 €	Sew-K-100/17-090/*	10,56 €	
110	Sew-K-100/11-110/*	17,38 €	Sew-K-100/17-110/*	13,86 €	
125	Sew-K-100/11-125/*	21,78 €	Sew-K-100/17-125/*	16,50 €	
140	Sew-K-100/11-140/*	26,84 €	Sew-K-100/17-140/*	21,34 €	
160	Sew-K-100/11-160/*	33,44 €	Sew-K-100/17-160/*	26,18 €	
180	Sew-K-100/11-180/*	40,26 €	Sew-K-100/17-180/*	31,68 €	
200	Sew-K-100/11-200/*	52,14 €	Sew-K-100/17-200/*	38,50 €	
225	Sew-K-100/11-225/*	63,36 €	Sew-K-100/17-225/*	47,74 €	
250	Sew-K-100/11-250/*	90,64 €	Sew-K-100/17-250/*	66,44 €	
280	Sew-K-100/11-280/*	119,02 €	Sew-K-100/17-280/*	82,28 €	
315	Sew-K-100/11-315/*	159,50 €	Sew-K-100/17-315/*	109,34 €	
355	Sew-K-100/11-355/*	250,80 €	Sew-K-100/17-355/*	163,24 €	
400	Sew-K-100/11-400/*	320,10 €	Sew-K-100/17-400/*	225,28 €	
450	Sew-K-100/11-450/*	525,36 €	Sew-K-100/17-450/*	375,98 €	
500	Sew-K-100/11-500/*	736,56 €	Sew-K-100/17-500/*	507,76 €	
560	Sew-K-100/11-560/*	1 038,40 €	Sew-K-100/17-560/*	678,04 €	
630	Sew-K-100/11-630/*	1 299,10 €	Sew-K-100/17-630/*	917,40 €	
710	Sew-K-100/11-710/*	2 035,22 €	Sew-K-100/17-710/*	1 355,64 €	
800	Sew-K-100/11-800/*	2 780,14 €	Sew-K-100/17-800/*	1 849,54 €	
900	Sew-K-100/11-900/*	on request	Sew-K-100/17-900/*	on request	
1000	Sew-K-100/11-000/*	on request	Sew-K-100/17-000/*	on request	
1200	Sew-K-100/11-012/*	on request	Sew-K-100/17-012/*	on request	

* degree (f.e. 30 for degree 30°; 60 for degree 60°)



Segmented elbow 31-60° PE100 SDR 11, SDR 17

Standard - pressure reduction factor 0,8

SDR11			SDR17		
d	Code	Price Net	Code	Price Net	
90	Sew-K-100/11-090/*	21,56 €	Sew-K-100/17-090/*	17,60 €	
110	Sew-K-100/11-110/*	28,16 €	Sew-K-100/17-110/*	24,20 €	
125	Sew-K-100/11-125/*	35,64 €	Sew-K-100/17-125/*	29,70 €	
140	Sew-K-100/11-140/*	43,56 €	Sew-K-100/17-140/*	36,08 €	
160	Sew-K-100/11-160/*	52,80 €	Sew-K-100/17-160/*	45,32 €	
180	Sew-K-100/11-180/*	66,44 €	Sew-K-100/17-180/*	55,66 €	
200	Sew-K-100/11-200/*	84,26 €	Sew-K-100/17-200/*	67,10 €	
225	Sew-K-100/11-225/*	105,82 €	Sew-K-100/17-225/*	81,40 €	
250	Sew-K-100/11-250/*	142,78 €	Sew-K-100/17-250/*	105,38 €	
280	Sew-K-100/11-280/*	186,12 €	Sew-K-100/17-280/*	129,36 €	
315	Sew-K-100/11-315/*	235,40 €	Sew-K-100/17-315/*	164,78 €	
355	Sew-K-100/11-355/*	355,30 €	Sew-K-100/17-355/*	245,52 €	
400	Sew-K-100/11-400/*	457,82 €	Sew-K-100/17-400/*	346,72 €	
450	Sew-K-100/11-450/*	803,66 €	Sew-K-100/17-450/*	542,96 €	
500	Sew-K-100/11-500/*	1 107,04 €	Sew-K-100/17-500/*	747,56 €	
560	Sew-K-100/11-560/*	1 479,28 €	Sew-K-100/17-560/*	1 025,64 €	
630	Sew-K-100/11-630/*	1 952,50 €	Sew-K-100/17-630/*	1 368,84 €	
710	Sew-K-100/11-710/*	3 341,58 €	Sew-K-100/17-710/*	2 248,62 €	
800	Sew-K-100/11-800/*	4 543,00 €	Sew-K-100/17-800/*	2 874,30 €	
900	Sew-K-100/11-900/*	on request	Sew-K-100/17-900/*	on request	
1000	Sew-K-100/11-000/*	on request	Sew-K-100/17-000/*	on request	
1200	Sew-K-100/11-012/*	on request	Sew-K-100/17-012/*	on request	

* degree (f.e. 30 for degree 30°; 60 for degree 60°)



Segmented elbow 61-90° PE100 SDR 11, SDR 17

Standard - pressure reduction factor 0,8



SDR11



SDR17

d	Code	Price Net	Code	Price Net
90	Sew-K-100/11-090/*	32,56 €	Sew-K-100/17-090/*	26,84 €
110	Sew-K-100/11-110/*	39,16 €	Sew-K-100/17-110/*	34,10 €
125	Sew-K-100/11-125/*	49,50 €	Sew-K-100/17-125/*	42,46 €
140	Sew-K-100/11-140/*	60,28 €	Sew-K-100/17-140/*	49,94 €
160	Sew-K-100/11-160/*	73,48 €	Sew-K-100/17-160/*	60,50 €
180	Sew-K-100/11-180/*	91,30 €	Sew-K-100/17-180/*	77,44 €
200	Sew-K-100/11-200/*	116,38 €	Sew-K-100/17-200/*	93,72 €
225	Sew-K-100/11-225/*	146,08 €	Sew-K-100/17-225/*	115,28 €
250	Sew-K-100/11-250/*	192,06 €	Sew-K-100/17-250/*	145,86 €
280	Sew-K-100/11-280/*	249,70 €	Sew-K-100/17-280/*	181,06 €
315	Sew-K-100/11-315/*	320,76 €	Sew-K-100/17-315/*	219,34 €
355	Sew-K-100/11-355/*	476,30 €	Sew-K-100/17-355/*	321,64 €
400	Sew-K-100/11-400/*	613,14 €	Sew-K-100/17-400/*	459,14 €
450	Sew-K-100/11-450/*	1 082,18 €	Sew-K-100/17-450/*	686,84 €
500	Sew-K-100/11-500/*	1 470,70 €	Sew-K-100/17-500/*	947,98 €
560	Sew-K-100/11-560/*	1 964,16 €	Sew-K-100/17-560/*	1 248,06 €
630	Sew-K-100/11-630/*	2 563,00 €	Sew-K-100/17-630/*	1 706,10 €
710	Sew-K-100/11-710/*	4 574,90 €	Sew-K-100/17-710/*	3 095,62 €
800	Sew-K-100/11-800/*	6 213,68 €	Sew-K-100/17-800/*	4 199,58 €
900	Sew-K-100/11-900/*	on request	Sew-K-100/17-900/*	on request
1000	Sew-K-100/11-000/*	on request	Sew-K-100/17-000/*	on request

* degree (f.e. 70 for degree 70°; 90 for degree 90°)



Segmented tee 90° PE100 SDR 11, SDR 17

Standard - pressure reduction factor 0,6



SDR11



SDR17

d	Code	Price Net	Code	Price Net
90	Sew-T-100/11-090	25,74 €	Sew-T-100/17-090	23,32 €
110	Sew-T-100/11-110	34,98 €	Sew-T-100/17-110	30,36 €
125	Sew-T-100/11-125	43,78 €	Sew-T-100/17-125	35,42 €
140	Sew-T-100/11-140	55,88 €	Sew-T-100/17-140	44,44 €
160	Sew-T-100/11-160	67,54 €	Sew-T-100/17-160	54,56 €
180	Sew-T-100/11-180	88,88 €	Sew-T-100/17-180	71,50 €
200	Sew-T-100/11-200	110,00 €	Sew-T-100/17-200	88,00 €
225	Sew-T-100/11-225	138,16 €	Sew-T-100/17-225	104,50 €
250	Sew-T-100/11-250	189,64 €	Sew-T-100/17-250	140,36 €
280	Sew-T-100/11-280	235,84 €	Sew-T-100/17-280	170,50 €
315	Sew-T-100/11-315	324,72 €	Sew-T-100/17-315	251,68 €
355	Sew-T-100/11-355	575,96 €	Sew-T-100/17-355	385,00 €
400	Sew-T-100/11-400	740,52 €	Sew-T-100/17-400	517,00 €
450	Sew-T-100/11-450	1 389,52 €	Sew-T-100/17-450	843,26 €
500	Sew-T-100/11-500	2 271,06 €	Sew-T-100/17-500	1 226,50 €
560	Sew-T-100/11-560	3 107,50 €	Sew-T-100/17-560	1 661,44 €
630	Sew-T-100/11-630	4 038,10 €	Sew-T-100/17-630	2 268,20 €
710	Sew-T-100/11-710	5 399,68 €	Sew-T-100/17-710	3 241,26 €
800	Sew-T-100/11-800	7 503,54 €	Sew-T-100/17-800	4 496,80 €
900	Sew-T-100/11-900	on request	Sew-T-100/17-900	on request
1000	Sew-T-100/11-000	on request	Sew-T-100/17-000	on request

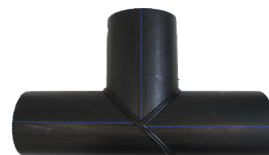
WODA KANALIZACJA 

Segmented tee 45° and 60° PE100 SDR 11, SDR 17

Standard - pressure reduction factor 0,6



SDR11



SDR17

d	Code	Price Net	Code	Price Net
90	Sew-T*-100/11-090	42,46 €	Sew-T*-100/17-090	37,18 €
110	Sew-T*-100/11-110	53,02 €	Sew-T*-100/17-110	46,64 €
125	Sew-T*-100/11-125	67,10 €	Sew-T*-100/17-125	55,22 €
140	Sew-T*-100/11-140	82,06 €	Sew-T*-100/17-140	67,76 €
160	Sew-T*-100/11-160	100,32 €	Sew-T*-100/17-160	81,62 €
180	Sew-T*-100/11-180	139,04 €	Sew-T*-100/17-180	106,04 €
200	Sew-T*-100/11-200	166,10 €	Sew-T*-100/17-200	132,00 €
225	Sew-T*-100/11-225	205,92 €	Sew-T*-100/17-225	155,98 €
250	Sew-T*-100/11-250	276,54 €	Sew-T*-100/17-250	193,60 €
280	Sew-T*-100/11-280	533,28 €	Sew-T*-100/17-280	375,98 €
315	Sew-T*-100/11-315	701,80 €	Sew-T*-100/17-315	503,14 €
355	Sew-T*-100/11-355	993,30 €	Sew-T*-100/17-355	671,00 €
400	Sew-T*-100/11-400	1 618,98 €	Sew-T*-100/17-400	1 120,46 €
450	Sew-T*-100/11-450	3 592,82 €	Sew-T*-100/17-450	2 398,22 €
500	Sew-T*-100/11-500	4 540,80 €	Sew-T*-100/17-500	3 128,18 €
560	Sew-T*-100/11-560	6 351,84 €	Sew-T*-100/17-560	4 474,14 €
630	Sew-T*-100/11-630	8 267,82 €	Sew-T*-100/17-630	5 593,28 €
710	Sew-T*-100/11-710	9 256,72 €	Sew-T*-100/17-710	8 161,12 €
800	Sew-T*-100/11-800	11 793,32 €	Sew-T*-100/17-800	10 417,22 €
900	Sew-T*-100/11-900	on request	Sew-T*-100/17-900	on request
1000	Sew-T*-100/11-000	on request	Sew-T*-100/17-000	on request

* degree (f.e. 45 for degree 30°; 45 for degree 60°)



Segmented cross PE100 SDR 11, SDR 17

Standard - pressure reduction factor 0,6



SDR11



SDR17

d	Code	Price Net	Code	Price Net
90	Sew- CZ -100/11-090	35,86 €	Sew- CZ -100/17-090	31,46 €
110	Sew- CZ -100/11-110	50,60 €	Sew- CZ -100/17-110	45,76 €
125	Sew- CZ -100/11-125	60,94 €	Sew- CZ -100/17-125	51,26 €
140	Sew- CZ -100/11-140	80,08 €	Sew- CZ -100/17-140	65,78 €
160	Sew- CZ -100/11-160	99,00 €	Sew- CZ -100/17-160	80,74 €
180	Sew- CZ -100/11-180	135,96 €	Sew- CZ -100/17-180	106,92 €
200	Sew- CZ -100/11-200	162,14 €	Sew- CZ -100/17-200	128,92 €
225	Sew- CZ -100/11-225	199,76 €	Sew- CZ -100/17-225	152,46 €
250	Sew- CZ -100/11-250	258,72 €	Sew- CZ -100/17-250	227,48 €
280	Sew- CZ -100/11-280	331,10 €	Sew- CZ -100/17-280	276,32 €
315	Sew- CZ -100/11-315	472,78 €	Sew- CZ -100/17-315	360,14 €
355	Sew- CZ -100/11-355	769,78 €	Sew- CZ -100/17-355	557,48 €
400	Sew- CZ -100/11-400	908,38 €	Sew- CZ -100/17-400	690,14 €
450	Sew- CZ -100/11-450	1 753,40 €	Sew- CZ -100/17-450	1 224,74 €
500	Sew- CZ -100/11-500	2 321,44 €	Sew- CZ -100/17-500	1 578,94 €
560	Sew- CZ -100/11-560	on request	Sew- CZ -100/17-560	on request
630	Sew- CZ -100/11-630	on request	Sew- CZ -100/17-630	on request
710	Sew- CZ -100/11-710	on request	Sew- CZ -100/17-710	on request
800	Sew- CZ -100/11-800	on request	Sew- CZ -100/17-800	on request
900	Sew- CZ -100/11-900	on request	Sew- CZ -100/17-900	on request
1000	Sew- CZ -100/11-000	on request	Sew- CZ -100/17-000	on request

WODA KANALIZACJA 

Segmented tee 90° reduced PE100 SDR 11, SDR 17

Standard - pressure reduction factor 0,6



SDR11



SDR17

d-d1	Code	Price Net	Code	Price Net
90-63	Sew-T-100/11-090/063	48,40 €	Sew-T-100/17-090/063	46,64 €
90-75	Sew-T-100/11-090/075	48,40 €	Sew-T-100/17-090/075	46,64 €
110-63	Sew-T-100/11-110/063	58,08 €	Sew-T-100/17-110/063	54,56 €
110-75	Sew-T-100/11-110/075	58,08 €	Sew-T-100/17-110/075	54,56 €
110-90	Sew-T-100/11-110/090	58,08 €	Sew-T-100/17-110/090	54,56 €
125-63	Sew-T-100/11-125/063	72,38 €	Sew-T-100/17-125/063	62,92 €
125-75	Sew-T-100/11-125/075	72,38 €	Sew-T-100/17-125/075	62,92 €
125-90	Sew-T-100/11-125/090	72,38 €	Sew-T-100/17-125/090	62,92 €
125-110	Sew-T-100/11-125/110	72,38 €	Sew-T-100/17-125/110	62,92 €
140-63	Sew-T-100/11-140/063	95,48 €	Sew-T-100/17-140/063	88,22 €
140-75	Sew-T-100/11-140/075	95,48 €	Sew-T-100/17-140/075	88,22 €
140-90	Sew-T-100/11-140/090	95,48 €	Sew-T-100/17-140/090	88,22 €
140-110	Sew-T-100/11-140/110	95,48 €	Sew-T-100/17-140/110	88,22 €
140-125	Sew-T-100/11-140/125	95,48 €	Sew-T-100/17-140/125	88,22 €
160-63	Sew-T-100/11-160/063	109,78 €	Sew-T-100/17-160/063	109,56 €
160-75	Sew-T-100/11-160/075	109,78 €	Sew-T-100/17-160/075	109,56 €
160-90	Sew-T-100/11-160/090	111,98 €	Sew-T-100/17-160/090	109,56 €
160-110	Sew-T-100/11-160/110	111,98 €	Sew-T-100/17-160/110	102,96 €
160-125	Sew-T-100/11-160/125	111,98 €	Sew-T-100/17-160/125	102,96 €
160-140	Sew-T-100/11-160/140	111,98 €	Sew-T-100/17-160/140	102,96 €
180-63	Sew-T-100/11-180/063	185,46 €	Sew-T-100/17-180/063	161,48 €
180-75	Sew-T-100/11-180/075	185,46 €	Sew-T-100/17-180/075	161,48 €
180-90	Sew-T-100/11-180/090	153,78 €	Sew-T-100/17-180/090	137,50 €
180-110	Sew-T-100/11-180/110	153,78 €	Sew-T-100/17-180/110	137,50 €
180-125	Sew-T-100/11-180/125	153,78 €	Sew-T-100/17-180/125	137,50 €
180-140	Sew-T-100/11-180/140	153,78 €	Sew-T-100/17-180/140	137,50 €
180-160	Sew-T-100/11-180/160	153,78 €	Sew-T-100/17-180/160	134,64 €
200-63	Sew-T-100/11-200/063	241,34 €	Sew-T-100/17-200/063	204,60 €
200-75	Sew-T-100/11-200/075	241,34 €	Sew-T-100/17-200/075	204,60 €
200-90	Sew-T-100/11-200/090	214,06 €	Sew-T-100/17-200/090	204,60 €
200-110	Sew-T-100/11-200/110	214,06 €	Sew-T-100/17-200/110	194,26 €
200-125	Sew-T-100/11-200/125	214,06 €	Sew-T-100/17-200/125	194,26 €
200-140	Sew-T-100/11-200/140	214,06 €	Sew-T-100/17-200/140	194,26 €
200-160	Sew-T-100/11-200/160	198,88 €	Sew-T-100/17-200/160	174,02 €
200-180	Sew-T-100/11-200/180	198,88 €	Sew-T-100/17-200/180	174,02 €
225-63	Sew-T-100/11-225/063	278,96 €	Sew-T-100/17-225/063	249,48 €
225-75	Sew-T-100/11-225/075	278,96 €	Sew-T-100/17-225/075	249,48 €
225-90	Sew-T-100/11-225/090	273,90 €	Sew-T-100/17-225/090	249,48 €
225-110	Sew-T-100/11-225/110	273,90 €	Sew-T-100/17-225/110	240,02 €
225-125	Sew-T-100/11-225/125	273,90 €	Sew-T-100/17-225/125	240,02 €
225-140	Sew-T-100/11-225/140	273,90 €	Sew-T-100/17-225/140	240,02 €
225-160	Sew-T-100/11-225/160	253,00 €	Sew-T-100/17-225/160	218,24 €
225-180	Sew-T-100/11-225/180	253,00 €	Sew-T-100/17-225/180	218,24 €
225-200	Sew-T-100/11-225/200	234,52 €	Sew-T-100/17-225/200	219,56 €
250-63	Sew-T-100/11-250/063	360,36 €	Sew-T-100/17-250/063	341,44 €
250-75	Sew-T-100/11-250/075	360,36 €	Sew-T-100/17-250/075	341,44 €
250-90	Sew-T-100/11-250/090	349,80 €	Sew-T-100/17-250/090	341,44 €
250-110	Sew-T-100/11-250/110	349,80 €	Sew-T-100/17-250/110	313,50 €
250-125	Sew-T-100/11-250/125	357,06 €	Sew-T-100/17-250/125	312,62 €
250-140	Sew-T-100/11-250/140	357,06 €	Sew-T-100/17-250/140	312,62 €
250-160	Sew-T-100/11-250/160	328,02 €	Sew-T-100/17-250/160	277,42 €
250-180	Sew-T-100/11-250/180	328,02 €	Sew-T-100/17-250/180	277,42 €
250-200	Sew-T-100/11-250/200	328,02 €	Sew-T-100/17-250/200	291,28 €

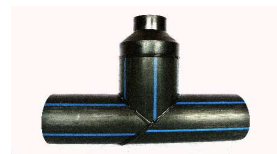

Segmented tee 90° reduced PE100 SDR 11, SDR 17

Standard - pressure reduction factor 0,6



SDR11



SDR17

d-d1	Code	Price Net	Code	Price Net
250-225	Sew-T-100/11-250/225	329,12 €	Sew-T-100/17-250/225	291,28 €
280-63	Sew-T-100/11-280/063	489,28 €	Sew-T-100/17-280/063	426,58 €
280-75	Sew-T-100/11-280/075	489,28 €	Sew-T-100/17-280/075	426,58 €
280-90	Sew-T-100/11-280/090	489,28 €	Sew-T-100/17-280/090	426,58 €
280-110	Sew-T-100/11-280/110	486,42 €	Sew-T-100/17-280/110	401,94 €
280-125	Sew-T-100/11-280/125	486,42 €	Sew-T-100/17-280/125	401,94 €
280-140	Sew-T-100/11-280/140	486,42 €	Sew-T-100/17-280/140	401,94 €
280-160	Sew-T-100/11-280/160	433,40 €	Sew-T-100/17-280/160	385,88 €
280-180	Sew-T-100/11-280/180	433,40 €	Sew-T-100/17-280/180	385,88 €
280-200	Sew-T-100/11-280/200	433,40 €	Sew-T-100/17-280/200	385,88 €
280-225	Sew-T-100/11-280/225	408,76 €	Sew-T-100/17-280/225	358,16 €
280-250	Sew-T-100/11-280/250	408,76 €	Sew-T-100/17-280/250	325,16 €
315-63	Sew-T-100/11-315/063	604,12 €	Sew-T-100/17-315/063	525,14 €
315-75	Sew-T-100/11-315/075	604,12 €	Sew-T-100/17-315/075	525,14 €
315-90	Sew-T-100/11-315/090	604,12 €	Sew-T-100/17-315/090	525,14 €
315-110	Sew-T-100/11-315/110	596,64 €	Sew-T-100/17-315/110	514,14 €
315-125	Sew-T-100/11-315/125	596,64 €	Sew-T-100/17-315/125	514,14 €
315-140	Sew-T-100/11-315/140	596,64 €	Sew-T-100/17-315/140	514,14 €
315-160	Sew-T-100/11-315/160	563,64 €	Sew-T-100/17-315/160	464,42 €
315-180	Sew-T-100/11-315/180	563,64 €	Sew-T-100/17-315/180	464,42 €
315-200	Sew-T-100/11-315/200	575,30 €	Sew-T-100/17-315/200	456,28 €
315-225	Sew-T-100/11-315/225	575,30 €	Sew-T-100/17-315/225	456,28 €
315-250	Sew-T-100/11-315/250	569,58 €	Sew-T-100/17-315/250	419,76 €
315-280	Sew-T-100/11-315/280	569,58 €	Sew-T-100/17-315/280	419,76 €
355-63	Sew-T-100/11-355/063	1 091,86 €	Sew-T-100/17-355/063	963,16 €
355-75	Sew-T-100/11-355/075	1 091,86 €	Sew-T-100/17-355/075	963,16 €
355-90	Sew-T-100/11-355/090	1 091,86 €	Sew-T-100/17-355/090	963,16 €
355-110	Sew-T-100/11-355/110	1 105,28 €	Sew-T-100/17-355/110	912,78 €
355-125	Sew-T-100/11-355/125	1 105,28 €	Sew-T-100/17-355/125	912,78 €
355-140	Sew-T-100/11-355/140	1 105,28 €	Sew-T-100/17-355/140	912,78 €
355-160	Sew-T-100/11-355/160	1 064,58 €	Sew-T-100/17-355/160	900,02 €
355-180	Sew-T-100/11-355/180	1 064,58 €	Sew-T-100/17-355/180	900,02 €
355-200	Sew-T-100/11-355/200	1 021,02 €	Sew-T-100/17-355/200	783,20 €
355-225	Sew-T-100/11-355/225	1 021,02 €	Sew-T-100/17-355/225	783,20 €
355-250	Sew-T-100/11-355/250	1 021,68 €	Sew-T-100/17-355/250	738,98 €
355-280	Sew-T-100/11-355/280	1 021,68 €	Sew-T-100/17-355/280	738,98 €
355-315	Sew-T-100/11-355/315	872,96 €	Sew-T-100/17-355/315	631,40 €
400-63	Sew-T-100/11-400/063	1 566,62 €	Sew-T-100/17-400/063	1 251,14 €
400-75	Sew-T-100/11-400/075	1 566,62 €	Sew-T-100/17-400/075	1 251,14 €
400-90	Sew-T-100/11-400/090	1 566,62 €	Sew-T-100/17-400/090	1 251,14 €
400-110	Sew-T-100/11-400/110	1 565,74 €	Sew-T-100/17-400/110	1 281,28 €
400-125	Sew-T-100/11-400/125	1 565,74 €	Sew-T-100/17-400/125	1 281,28 €
400-140	Sew-T-100/11-400/140	1 565,74 €	Sew-T-100/17-400/140	1 281,28 €
400-160	Sew-T-100/11-400/160	1 527,02 €	Sew-T-100/17-400/160	1 245,64 €
400-180	Sew-T-100/11-400/180	1 527,02 €	Sew-T-100/17-400/180	1 245,64 €
400-200	Sew-T-100/11-400/200	1 407,56 €	Sew-T-100/17-400/200	1 145,76 €
400-225	Sew-T-100/11-400/225	1 460,36 €	Sew-T-100/17-400/225	1 145,76 €
400-250	Sew-T-100/11-400/250	1 301,96 €	Sew-T-100/17-400/250	1 091,20 €
400-280	Sew-T-100/11-400/280	1 301,96 €	Sew-T-100/17-400/280	1 091,20 €
400-315	Sew-T-100/11-400/315	1 211,10 €	Sew-T-100/17-400/315	975,04 €
400-355	Sew-T-100/11-400/355	1 211,10 €	Sew-T-100/17-400/355	944,46 €

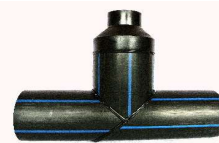

Segmented tee 90° with steel flange PE100 SDR 11, SDR 17

Standard - pressure reduction factor 0,6



SDR11



SDR17

d-d1	Code	Price Net	Code	Price Net
90 - 50	Sew-TK-100/11-090/050	75,68 €	Sew-TK-100/17-090/050	70,40 €
90 - 65	Sew-TK-100/11-090/065	75,68 €	Sew-TK-100/17-090/065	70,40 €
90 - 80	Sew-TK-100/11-090/080	65,56 €	Sew-TK-100/17-090/080	62,92 €
110 - 50	Sew-TK-100/11-110/050	85,14 €	Sew-TK-100/17-110/050	80,30 €
110 - 65	Sew-TK-100/11-110/065	85,14 €	Sew-TK-100/17-110/065	80,30 €
110 - 80	Sew-TK-100/11-110/080	92,40 €	Sew-TK-100/17-110/080	86,24 €
110 - 100	Sew-TK-100/11-110/100	88,44 €	Sew-TK-100/17-110/100	79,42 €
125 - 50	Sew-TK-100/11-125/050	98,56 €	Sew-TK-100/17-125/050	92,62 €
125 - 65	Sew-TK-100/11-125/065	98,56 €	Sew-TK-100/17-125/065	92,62 €
125 - 80	Sew-TK-100/11-125/080	108,24 €	Sew-TK-100/17-125/080	102,74 €
125 - 100	Sew-TK-100/11-125/100	113,30 €	Sew-TK-100/17-125/100	102,96 €
140 - 50	Sew-TK-100/11-140/050	118,36 €	Sew-TK-100/17-140/050	93,06 €
140 - 65	Sew-TK-100/11-140/065	118,36 €	Sew-TK-100/17-140/065	93,06 €
140 - 80	Sew-TK-100/11-140/080	114,40 €	Sew-TK-100/17-140/080	103,40 €
140 - 100	Sew-TK-100/11-140/100	118,36 €	Sew-TK-100/17-140/100	113,96 €
140 - 125	Sew-TK-100/11-140/125	118,36 €	Sew-TK-100/17-140/125	113,96 €
160 - 50	Sew-TK-100/11-160/050	144,98 €	Sew-TK-100/17-160/050	134,64 €
160 - 65	Sew-TK-100/11-160/065	144,98 €	Sew-TK-100/17-160/065	134,64 €
160 - 80	Sew-TK-100/11-160/080	143,00 €	Sew-TK-100/17-160/080	139,48 €
160 - 100	Sew-TK-100/11-160/100	153,12 €	Sew-TK-100/17-160/100	146,74 €
160 - 125	Sew-TK-100/11-160/125	153,12 €	Sew-TK-100/17-160/125	146,74 €
160 - 150	Sew-TK-100/11-160/150	152,02 €	Sew-TK-100/17-160/150	135,30 €
180 - 50	Sew-TK-100/11-180/050	206,80 €	Sew-TK-100/17-180/050	189,64 €
180 - 65	Sew-TK-100/11-180/065	206,80 €	Sew-TK-100/17-180/065	189,64 €
180 - 80	Sew-TK-100/11-180/080	181,72 €	Sew-TK-100/17-180/080	176,66 €
180 - 100	Sew-TK-100/11-180/100	199,32 €	Sew-TK-100/17-180/100	196,46 €
180 - 125	Sew-TK-100/11-180/125	199,32 €	Sew-TK-100/17-180/125	196,46 €
180 - 150	Sew-TK-100/11-180/150	221,98 €	Sew-TK-100/17-180/150	179,96 €
200 - 50	Sew-TK-100/11-200/050	284,02 €	Sew-TK-100/17-200/050	255,64 €
200 - 65	Sew-TK-100/11-200/065	284,02 €	Sew-TK-100/17-200/065	255,64 €
200 - 80	Sew-TK-100/11-200/080	243,98 €	Sew-TK-100/17-200/080	233,42 €
200 - 100	Sew-TK-100/11-200/100	260,26 €	Sew-TK-100/17-200/100	254,32 €
200 - 125	Sew-TK-100/11-200/125	260,26 €	Sew-TK-100/17-200/125	254,32 €
200 - 150	Sew-TK-100/11-200/150	271,92 €	Sew-TK-100/17-200/150	259,60 €
200 - 200	Sew-TK-100/11-200/200	238,26 €	Sew-TK-100/17-200/200	209,44 €
225 - 50	Sew-TK-100/11-225/050	314,82 €	Sew-TK-100/17-225/050	303,82 €
225 - 65	Sew-TK-100/11-225/065	314,82 €	Sew-TK-100/17-225/065	303,82 €
225 - 80	Sew-TK-100/11-225/080	305,14 €	Sew-TK-100/17-225/080	304,04 €
225 - 100	Sew-TK-100/11-225/100	324,94 €	Sew-TK-100/17-225/100	316,80 €
225 - 125	Sew-TK-100/11-225/125	324,94 €	Sew-TK-100/17-225/125	316,80 €
225 - 150	Sew-TK-100/11-225/150	333,52 €	Sew-TK-100/17-225/150	306,02 €
225 - 200	Sew-TK-100/11-225/200	314,16 €	Sew-TK-100/17-225/200	251,24 €
250 - 50	Sew-TK-100/11-250/050	383,46 €	Sew-TK-100/17-250/050	357,06 €
250 - 65	Sew-TK-100/11-250/065	383,46 €	Sew-TK-100/17-250/065	357,06 €
250 - 80	Sew-TK-100/11-250/080	374,88 €	Sew-TK-100/17-250/080	341,44 €
250 - 100	Sew-TK-100/11-250/100	390,94 €	Sew-TK-100/17-250/100	357,06 €
250 - 125	Sew-TK-100/11-250/125	390,94 €	Sew-TK-100/17-250/125	357,06 €
250 - 150	Sew-TK-100/11-250/150	396,44 €	Sew-TK-100/17-250/150	345,62 €
250 - 200	Sew-TK-100/11-250/200	405,46 €	Sew-TK-100/17-250/200	388,96 €
250 - 250	Sew-TK-100/11-250/250	405,46 €	Sew-TK-100/17-250/250	367,40 €

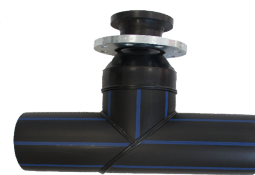

Segmented tee 90° with steel flange PE100 SDR 11, SDR 17

Standard - pressure reduction factor 0,6



SDR11



SDR17

d-d1	Code	Price Net	Code	Price Net
280 - 50	Sew-TK-100/11-280/050	500,94 €	Sew-TK-100/17-280/050	446,60 €
280 - 65	Sew-TK-100/11-280/065	500,94 €	Sew-TK-100/17-280/065	446,60 €
280 - 80	Sew-TK-100/11-280/080	501,82 €	Sew-TK-100/17-280/080	455,84 €
280 - 100	Sew-TK-100/11-280/100	507,54 €	Sew-TK-100/17-280/100	472,56 €
280 - 125	Sew-TK-100/11-280/125	507,54 €	Sew-TK-100/17-280/125	472,56 €
280 - 150	Sew-TK-100/11-280/150	502,26 €	Sew-TK-100/17-280/150	465,96 €
280 - 200	Sew-TK-100/11-280/200	533,50 €	Sew-TK-100/17-280/200	455,84 €
280 - 250	Sew-TK-100/11-280/250	522,06 €	Sew-TK-100/17-280/250	410,74 €
315 - 50	Sew-TK-100/11-315/050	633,38 €	Sew-TK-100/17-315/050	553,52 €
315 - 65	Sew-TK-100/11-315/065	633,38 €	Sew-TK-100/17-315/065	553,52 €
315 - 80	Sew-TK-100/11-315/080	632,28 €	Sew-TK-100/17-315/080	538,34 €
315 - 100	Sew-TK-100/11-315/100	647,46 €	Sew-TK-100/17-315/100	553,52 €
315 - 125	Sew-TK-100/11-315/125	647,46 €	Sew-TK-100/17-315/125	553,52 €
315 - 150	Sew-TK-100/11-315/150	650,32 €	Sew-TK-100/17-315/150	544,50 €
315 - 200	Sew-TK-100/11-315/200	654,94 €	Sew-TK-100/17-315/200	580,58 €
315 - 250	Sew-TK-100/11-315/250	652,30 €	Sew-TK-100/17-315/250	630,30 €
315 - 300	Sew-TK-100/11-315/300	636,46 €	Sew-TK-100/17-315/300	520,08 €
355 - 100	Sew-TK-100/11-355/100	1 152,80 €	Sew-TK-100/17-355/100	1 032,24 €
355 - 125	Sew-TK-100/11-355/125	1 152,80 €	Sew-TK-100/17-355/125	1 032,24 €
355 - 150	Sew-TK-100/11-355/150	1 141,14 €	Sew-TK-100/17-355/150	1 001,44 €
355 - 200	Sew-TK-100/11-355/200	1 094,94 €	Sew-TK-100/17-355/200	912,78 €
355 - 250	Sew-TK-100/11-355/250	1 131,90 €	Sew-TK-100/17-355/250	963,16 €
355 - 300	Sew-TK-100/11-355/300	1 102,42 €	Sew-TK-100/17-355/300	885,06 €
355 - 350	Sew-TK-100/11-355/350	938,52 €	Sew-TK-100/17-355/350	846,34 €
400 - 50	Sew-TK-100/11-400/050	1 534,28 €	Sew-TK-100/17-400/050	1 366,20 €
400 - 65	Sew-TK-100/11-400/065	1 534,28 €	Sew-TK-100/17-400/065	1 366,20 €
400 - 80	Sew-TK-100/11-400/080	1 525,92 €	Sew-TK-100/17-400/080	1 308,34 €
400 - 100	Sew-TK-100/11-400/100	1 510,74 €	Sew-TK-100/17-400/100	1 325,06 €
400 - 125	Sew-TK-100/11-400/125	1 510,74 €	Sew-TK-100/17-400/125	1 325,06 €
400 - 150	Sew-TK-100/11-400/150	1 532,08 €	Sew-TK-100/17-400/150	1 313,84 €
400 - 200	Sew-TK-100/11-400/200	1 495,56 €	Sew-TK-100/17-400/200	1 255,76 €
400 - 250	Sew-TK-100/11-400/250	1 535,60 €	Sew-TK-100/17-400/250	1 314,50 €
400 - 300	Sew-TK-100/11-400/300	1 502,38 €	Sew-TK-100/17-400/300	1 230,02 €
400 - 350	Sew-TK-100/11-400/350	1 535,60 €	Sew-TK-100/17-400/350	1 422,08 €
400 - 400	Sew-TK-100/11-400/400	1 336,72 €	Sew-TK-100/17-400/400	1 120,90 €

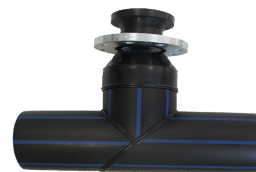

Wyes segmented tee 45° i 60° reduced PE100 SDR 11, SDR 17

Standard - pressure reduction factor 0,6



SDR11



SDR17

d-d1	Code	Price Net	Code	Price Net
90-63	Sew-T*-100/11-090/063	53,46 €	Sew-T*-100/17-090/063	47,08 €
90-75	Sew-T*-100/11-090/075	53,46 €	Sew-T*-100/17-090/075	47,08 €
110-63	Sew-T*-100/11-110/063	76,78 €	Sew-T*-100/17-110/063	71,50 €
110-75	Sew-T*-100/11-110/075	76,78 €	Sew-T*-100/17-110/075	71,50 €
110-90	Sew-T*-100/11-110/090	76,78 €	Sew-T*-100/17-110/090	71,50 €
125-63	Sew-T*-100/11-125/063	93,06 €	Sew-T*-100/17-125/063	81,18 €
125-75	Sew-T*-100/11-125/075	93,06 €	Sew-T*-100/17-125/075	81,18 €
125-90	Sew-T*-100/11-125/090	93,06 €	Sew-T*-100/17-125/090	81,18 €
125-110	Sew-T*-100/11-125/110	93,06 €	Sew-T*-100/17-125/110	81,18 €
140-63	Sew-T*-100/11-140/063	135,08 €	Sew-T*-100/17-140/063	128,48 €
140-75	Sew-T*-100/11-140/075	135,08 €	Sew-T*-100/17-140/075	128,48 €
140-90	Sew-T*-100/11-140/090	135,08 €	Sew-T*-100/17-140/090	128,48 €
140-110	Sew-T*-100/11-140/110	135,08 €	Sew-T*-100/17-140/110	128,48 €
140-125	Sew-T*-100/11-140/125	135,08 €	Sew-T*-100/17-140/125	128,48 €
160-63	Sew-T*-100/11-160/063	145,42 €	Sew-T*-100/17-160/063	123,20 €
160-75	Sew-T*-100/11-160/075	145,42 €	Sew-T*-100/17-160/075	123,20 €
160-90	Sew-T*-100/11-160/090	145,42 €	Sew-T*-100/17-160/090	123,20 €
160-110	Sew-T*-100/11-160/110	145,42 €	Sew-T*-100/17-160/110	123,20 €
160-125	Sew-T*-100/11-160/125	145,42 €	Sew-T*-100/17-160/125	123,20 €
160-140	Sew-T*-100/11-160/140	145,42 €	Sew-T*-100/17-160/140	123,20 €
180-63	Sew-T*-100/11-180/063	204,38 €	Sew-T*-100/17-180/063	186,12 €
180-75	Sew-T*-100/11-180/075	204,38 €	Sew-T*-100/17-180/075	186,12 €
180-90	Sew-T*-100/11-180/090	204,38 €	Sew-T*-100/17-180/090	185,24 €
180-110	Sew-T*-100/11-180/110	204,38 €	Sew-T*-100/17-180/110	185,24 €
180-125	Sew-T*-100/11-180/125	204,38 €	Sew-T*-100/17-180/125	185,24 €
180-140	Sew-T*-100/11-180/140	204,38 €	Sew-T*-100/17-180/140	185,24 €
180-160	Sew-T*-100/11-180/160	204,38 €	Sew-T*-100/17-180/160	165,00 €
200-63	Sew-T*-100/11-200/063	299,86 €	Sew-T*-100/17-200/063	267,08 €
200-75	Sew-T*-100/11-200/075	299,86 €	Sew-T*-100/17-200/075	267,08 €
200-90	Sew-T*-100/11-200/090	299,86 €	Sew-T*-100/17-200/090	261,80 €
200-110	Sew-T*-100/11-200/110	295,90 €	Sew-T*-100/17-200/110	261,80 €
200-125	Sew-T*-100/11-200/125	295,90 €	Sew-T*-100/17-200/125	267,08 €
200-140	Sew-T*-100/11-200/140	295,90 €	Sew-T*-100/17-200/140	267,08 €
200-160	Sew-T*-100/11-200/160	278,52 €	Sew-T*-100/17-200/160	228,36 €
200-180	Sew-T*-100/11-200/180	278,52 €	Sew-T*-100/17-200/180	220,88 €
225-63	Sew-T*-100/11-225/063	375,32 €	Sew-T*-100/17-225/063	295,02 €
225-75	Sew-T*-100/11-225/075	375,32 €	Sew-T*-100/17-225/075	295,02 €
225-90	Sew-T*-100/11-225/090	373,56 €	Sew-T*-100/17-225/090	290,40 €
225-110	Sew-T*-100/11-225/110	373,56 €	Sew-T*-100/17-225/110	290,40 €
225-125	Sew-T*-100/11-225/125	373,56 €	Sew-T*-100/17-225/125	290,40 €
225-140	Sew-T*-100/11-225/140	373,56 €	Sew-T*-100/17-225/140	290,40 €
225-160	Sew-T*-100/11-225/160	353,54 €	Sew-T*-100/17-225/160	269,50 €
225-180	Sew-T*-100/11-225/180	353,54 €	Sew-T*-100/17-225/180	258,06 €
225-200	Sew-T*-100/11-225/200	370,92 €	Sew-T*-100/17-225/200	258,06 €
250-63	Sew-T*-100/11-250/063	435,82 €	Sew-T*-100/17-250/063	358,82 €
250-75	Sew-T*-100/11-250/075	435,82 €	Sew-T*-100/17-250/075	358,82 €
250-90	Sew-T*-100/11-250/090	433,18 €	Sew-T*-100/17-250/090	353,54 €
250-110	Sew-T*-100/11-250/110	433,18 €	Sew-T*-100/17-250/110	353,54 €
250-125	Sew-T*-100/11-250/125	435,82 €	Sew-T*-100/17-250/125	362,34 €
250-140	Sew-T*-100/11-250/140	435,82 €	Sew-T*-100/17-250/140	362,34 €
250-160	Sew-T*-100/11-250/160	395,78 €	Sew-T*-100/17-250/160	324,28 €
250-180	Sew-T*-100/11-250/180	395,78 €	Sew-T*-100/17-250/180	352,66 €
250-200	Sew-T*-100/11-250/200	392,48 €	Sew-T*-100/17-250/200	309,98 €



* degree (f.e. 45 for degree 30°, 45 for degree 60°)

WODA KANALIZACJA 

Wyes segmented tee 45° i 60° reduced PE100 SDR 11, SDR 17

Standard - pressure reduction factor 0,6



SDR11



SDR17

d-d1	Code	Price Net	Code	Price Net
250-225	Sew-T*-100/11-250/225	357,50 €	Sew-T*-100/17-250/225	309,98 €
280-63	Sew-T*-100/11-280/063	854,04 €	Sew-T*-100/17-280/063	704,66 €
280-75	Sew-T*-100/11-280/075	854,04 €	Sew-T*-100/17-280/075	704,66 €
280-90	Sew-T*-100/11-280/090	854,04 €	Sew-T*-100/17-280/090	682,88 €
280-110	Sew-T*-100/11-280/110	834,02 €	Sew-T*-100/17-280/110	682,88 €
280-125	Sew-T*-100/11-280/125	834,02 €	Sew-T*-100/17-280/125	682,88 €
280-140	Sew-T*-100/11-280/140	834,46 €	Sew-T*-100/17-280/140	682,88 €
280-160	Sew-T*-100/11-280-160	775,94 €	Sew-T*-100/17-280-160	622,38 €
280-180	Sew-T*-100/11-280/180	833,36 €	Sew-T*-100/17-280/180	680,68 €
280-200	Sew-T*-100/11-280/200	779,68 €	Sew-T*-100/17-280/200	623,92 €
280-225	Sew-T*-100/11-280/225	773,08 €	Sew-T*-100/17-280/225	612,70 €
280-250	Sew-T*-100/11-280/250	773,08 €	Sew-T*-100/17-280/250	614,24 €
315-63	Sew-T*-100/11-315/063	1 002,76 €	Sew-T*-100/17-315/063	865,48 €
315-75	Sew-T*-100/11-315/075	1 002,76 €	Sew-T*-100/17-315/075	865,48 €
315-90	Sew-T*-100/11-315/090	999,46 €	Sew-T*-100/17-315/090	861,96 €
315-110	Sew-T*-100/11-315/110	999,46 €	Sew-T*-100/17-315/110	861,96 €
315-125	Sew-T*-100/11-315/125	997,70 €	Sew-T*-100/17-315/125	861,96 €
315-140	Sew-T*-100/11-315/140	997,70 €	Sew-T*-100/17-315/140	861,96 €
315-160	Sew-T*-100/11-315-160	972,62 €	Sew-T*-100/17-315-160	833,36 €
315-180	Sew-T*-100/11-315/180	987,14 €	Sew-T*-100/17-315/180	844,58 €
315-200	Sew-T*-100/11-315/200	987,14 €	Sew-T*-100/17-315/200	844,58 €
315-225	Sew-T*-100/11-315/225	973,06 €	Sew-T*-100/17-315/225	826,10 €
315-250	Sew-T*-100/11-315/250	973,06 €	Sew-T*-100/17-315/250	826,10 €
315-280	Sew-T*-100/11-315/280	971,74 €	Sew-T*-100/17-315/280	826,10 €

* degree (f.e. 45 for degree 30°; 45 for degree 60°)



Offsets and by-passes 45° PE100 SDR 11, SDR 17 H=30cm

Standard - pressure reduction factor 0,8



SDR11



SDR17

d	Code	Price Net	Code	Price Net
90	Sew-UK-100/11-090	33,00 €	Sew-UK-100/17-090	26,62 €
110	Sew-UK-100/11-110	36,30 €	Sew-UK-100/17-110	34,32 €
125	Sew-UK-100/11-125	47,52 €	Sew-UK-100/17-125	41,58 €
140	Sew-UK-100/11-140	57,64 €	Sew-UK-100/17-140	49,28 €
160	Sew-UK-100/11-160	65,78 €	Sew-UK-100/17-160	58,30 €
180	Sew-UK-100/11-180	91,08 €	Sew-UK-100/17-180	80,08 €
200	Sew-UK-100/11-200	113,74 €	Sew-UK-100/17-200	101,20 €
225	Sew-UK-100/11-225	136,84 €	Sew-UK-100/17-225	118,36 €
250	Sew-UK-100/11-250	184,80 €	Sew-UK-100/17-250	154,66 €
280	Sew-UK-100/11-280	231,88 €	Sew-UK-100/17-280	196,24 €
315	Sew-UK-100/11-315	300,96 €	Sew-UK-100/17-315	237,60 €



WODA



KANALIZACJA



Segmented wyes tee 45° with elbow 60° reduced PE100 SDR 11, SDR 17

Standard - pressure reduction factor 0,8



SDR11

d-d1	Code	Price Net	Code	Price Net
110-90	Sew-TŁ-100/11-110/090	94,58 €	Sew-TŁ-100/17-110/090	90,17 €
125-90	Sew-TŁ-100/11-125/090	109,34 €	Sew-TŁ-100/17-125/090	102,61 €
125-110	Sew-TŁ-100/11-125/110	114,53 €	Sew-TŁ-100/17-125/110	109,09 €
160-90	Sew-TŁ-100/11-160/090	139,40 €	Sew-TŁ-100/17-160/090	135,26 €
160-110	Sew-TŁ-100/11-160/110	143,29 €	Sew-TŁ-100/17-160/110	139,40 €
180-90	Sew-TŁ-100/11-180/090	200,29 €	Sew-TŁ-100/17-180/090	184,49 €
180-110	Sew-TŁ-100/11-180/110	204,70 €	Sew-TŁ-100/17-180/110	189,15 €
200-90	Sew-TŁ-100/11-200/090	277,77 €	Sew-TŁ-100/17-200/090	253,41 €
200-110	Sew-TŁ-100/11-200/110	280,88 €	Sew-TŁ-100/17-200/110	266,88 €
200-125	Sew-TŁ-100/11-200/125	288,13 €	Sew-TŁ-100/17-200/125	272,58 €
200-160	Sew-TŁ-100/11-200/160	290,20 €	Sew-TŁ-100/17-200/160	249,01 €
225-90	Sew-TŁ-100/11-225/090	346,17 €	Sew-TŁ-100/17-225/090	280,36 €
225-110	Sew-TŁ-100/11-225/110	350,06 €	Sew-TŁ-100/17-225/110	284,24 €
225-125	Sew-TŁ-100/11-225/125	423,91 €	Sew-TŁ-100/17-225/125	304,71 €
225-160	Sew-TŁ-100/11-225/160	394,89 €	Sew-TŁ-100/17-225/160	290,20 €
250-90	Sew-TŁ-100/11-250/090	398,25 €	Sew-TŁ-100/17-250/090	334,77 €
250-110	Sew-TŁ-100/11-250/110	403,70 €	Sew-TŁ-100/17-250/110	339,44 €
250-125	Sew-TŁ-100/11-250/125	423,91 €	Sew-TŁ-100/17-250/125	371,82 €
250-160	Sew-TŁ-100/11-250/160	394,89 €	Sew-TŁ-100/17-250/160	337,10 €



Segmented Y tee PE100 SDR 11, SDR 17

Standard - pressure reduction factor 0,6



SDR11

d	Code	Price Net	Code	Price Net
90	Sew-TY-100/11-090	33,00 €	Sew-TY-100/17-090	26,62 €
110	Sew-TY-100/11-110	36,30 €	Sew-TY-100/17-110	34,32 €
125	Sew-TY-100/11-125	47,52 €	Sew-TY-100/17-125	41,58 €
140	Sew-TY-100/11-140	57,64 €	Sew-TY-100/17-140	49,28 €
160	Sew-TY-100/11-160	65,78 €	Sew-TY-100/17-160	58,30 €
180	Sew-TY-100/11-180	91,08 €	Sew-TY-100/17-180	80,08 €
200	Sew-TY-100/11-200	113,74 €	Sew-TY-100/17-200	101,20 €
225	Sew-TY-100/11-225	136,84 €	Sew-TY-100/17-225	118,36 €
250	Sew-TY-100/11-250	184,80 €	Sew-TY-100/17-250	154,66 €
280	Sew-TY-100/11-280	231,88 €	Sew-TY-100/17-280	196,24 €
315	Sew-TY-100/11-315	300,96 €	Sew-TY-100/17-315	237,60 €

WODA KANALIZACJA 

Electrofusion coupler PE100 SDR11

+GF+



d	Code	Price Net	Code	Price Net
20	GF-753911056	3,43 €		
25	GF-753911057	3,94 €		
32	GF-753911058	4,22 €	PLA-MP032C	3,81 €
40	GF-753911059	4,44 €	PLA-MP040C	4,00 €
50	GF-753911060	6,91 €	PLA-MP050C	6,20 €
63	GF-753911061	7,19 €	PLA-MP063C	6,51 €
75	GF-753911062	10,12 €	PLA-MP075C	9,13 €
90	GF-753911063	13,49 €	PLA-MP090C	12,17 €
110	GF-753911064	16,50 €	PLA-MP110C	14,89 €
125	GF-753911065	22,62 €	PLA-MP125C	20,33 €
140	GF-753911066	26,00 €	PLA-MP140C	24,60 €
160	GF-753911067	30,07 €	PLA-MP160C	26,95 €
180	GF-753911068	45,10 €	PLA-MP180C	40,48 €
200	GF-753911069	52,36 €	PLA-MP200C	47,30 €
225	GF-753911070	64,24 €	PLA-MP225C	57,86 €
250	GF-753911071	90,42 €	PLA-MP250C	81,84 €
280	GF-753911072	127,82 €	PLA-MP280C	115,06 €
315	GF-753911073	146,52 €	PLA-MP315C	131,78 €
355	GF-753911704	235,84 €	PLA-MP355C	234,30 €
400	GF-753911705	289,74 €	PLA-MP400C	352,66 €
450	GF-753911706	599,06 €	PLA-MP450C	537,24 €
500	GF-753911707	740,74 €	PLA-MP500C	691,24 €
560	GF-753911708	1 689,60 €		
630	GF-753911709	2 589,62 €		
710	GF-753911710	3 451,80 €		
800	GF-753911711	4 952,42 €		
900*	GF-753911652	on request		



* without GAS certyficate

PLA-MP* without GAS certyficateC

Electrofusion coupler PE100 SDR17

+GF+



d	Code	Price Net	Code	Price Net
160	GF-753911077	24,64 €	PLA-MP160B	22,44 €
180	GF-753911078	37,18 €	PLA-MP180B	33,66 €
200	GF-753911079	42,68 €	PLA-MP200B	38,50 €
225	GF-753911080	52,80 €	PLA-MP225B	47,96 €
250	GF-753911081	74,14 €	PLA-MP250B	66,66 €
280	GF-753911082	104,94 €	PLA-MP280B	94,38 €
315	GF-753911083	120,12 €	PLA-MP315B	107,80 €
355	GF-753911804	226,38 €	PLA-MP355B	191,84 €
400	GF-753911805	277,86 €	PLA-MP400B	244,42 €
450	GF-753911806	421,30 €	PLA-MP450B	369,60 €
500	GF-753911807	452,54 €	PLA-MP500B	414,04 €
560	GF-753911808	1 331,66 €	PLA-MP560B	801,46 €
630	GF-753911809	1 680,80 €	PLA-MP630B	1 011,78 €
710	GF-753911810	2 336,40 €		
800	GF-753911811	3 142,70 €		
900*	GF-753911852	on request		
1000*	GF-753911853	on request		

GAZ WODA KANALIZACJA 

* without GAS certyficate

Electrofusion elbow 90° PE100 SDR11

+GF+

d	Code	Price Net	Code	Price Net
20	GF-753101606	11,48 €		
25	GF-753101607	11,48 €		
32	GF-753101608	12,12 €	PLA-GE9P032C	11,29 €
40	GF-753101609	14,50 €	PLA-GE9P040C	13,07 €
50	GF-753101610	18,15 €	PLA-GE9P050C	16,28 €
63	GF-753101611	20,53 €	PLA-GE9P063C	18,46 €
75	GF-753101612	29,61 €	PLA-GE9P075C	26,62 €
90	GF-753101813	36,72 €	PLA-GE9P090C	29,44 €
110	GF-753101814	52,80 €	PLA-GE9P110C	42,68 €
125	GF-753101815	72,82 €	PLA-GE9P125C	58,52 €
140	GF-753101816	100,32 €	PLA-GE9P140C	91,74 €
160	GF-753101817	144,76 €	PLA-GE9P160C	103,18 €
180	GF-753101818	181,50 €	PLA-GE9P180C	137,28 €
200	GF-753101819	434,72 €	PLA-GE9P200C	314,82 €
225	GF-753101820	536,14 €	PLA-GE9P225C	399,96 €
250	GF-753101821	696,96 €	PLA-GE9P250C	543,62 €
315			PLA-GE9P315C	704,22 €



Electrofusion elbow 45° PE100 SDR11

+GF+

d	Code	Price Net	Code	Price Net
32	GF-753151608	12,12 €	PLA-GE4P032C	11,29 €
40	GF-753151609	14,19 €	PLA-GE4P040C	13,07 €
50	GF-753151610	18,15 €	PLA-GE4P050C	16,28 €
63	GF-753151611	20,53 €	PLA-GE4P063C	18,46 €
75	GF-753151612	29,61 €	PLA-GE4P075C	26,62 €
90	GF-753151813	36,72 €	PLA-GE4P090C	29,44 €
110	GF-753151814	52,80 €	PLA-GE4P110C	42,68 €
125	GF-753151815	72,82 €	PLA-GE4P125C	58,52 €
140	GF-753151816	100,32 €	PLA-GE4P140C	91,74 €
160	GF-753151817	144,76 €	PLA-GE4P160C	103,18 €
180	GF-753151818	181,50 €	PLA-GE4P180C	137,28 €
200	GF-753151819	434,72 €	PLA-GE4P200C	314,82 €
225	GF-753151820	536,14 €	PLA-GE4P225C	399,96 €
250	GF-753151821	696,96 €	PLA-GE4P250C	543,62 €
315			PLA-GE4P315C	704,22 €

GAZ WODA KANALIZACJA 

Electrofusion tee 90° PE100 SDR11

+GF+



d	Code	Price Net	Code	Price Net
20	GF-753211606	12,54 €		
25	GF-753211607	12,54 €		
32	GF-753211608	12,54 €	PLA-TEP032C	11,22 €
40	GF-753211609	14,52 €	PLA-TEP040C	13,20 €
50	GF-753211610	18,26 €	PLA-TEP050C	16,72 €
63	GF-753211611	21,12 €	PLA-TEP063C	19,58 €
75	GF-753211612	27,72 €	PLA-TEP075C	25,08 €
90	GF-753211813	34,32 €	PLA-TEP090C	32,12 €
110	GF-753211814	53,68 €	PLA-TEP110C	48,62 €
125	GF-753211815	70,40 €	PLA-TEP125C	63,14 €
140	GF-753211816	88,88 €		
160	GF-753211817	126,72 €	PLA-TEP160C	108,68 €
180	GF-753201818	192,72 €	PLA-TEP180C	155,54 €
200	GF-753201819	434,72 €	PLA-TEP200C	333,30 €
225	GF-753201820	561,66 €	PLA-TEP225C	429,00 €
250	GF-753201821	703,56 €	PLA-TEP250C	534,82 €
			PLA-TEP315C	836,00 €



Electrofusion reducer PE100 SDR11

+GF+



d	Code	Price Net	Code	Price Net
25-20	GF-753901639	8,36 €		
32-20	GF-753901640	8,36 €		
32-25	GF-753901641	8,36 €		
40-20	GF-753901644	11,00 €		
40-25	GF-753901645	11,00 €	PLA-REP040025C	11,00 €
40-32	GF-753901646	11,00 €	PLA-REP040032C	9,68 €
50-32	GF-753901651	13,20 €	PLA-REP050032C	11,88 €
50-40	GF-753901652	14,74 €	PLA-REP050040C	12,98 €
63-32	GF-753901656	16,50 €	PLA-REP063032C	14,52 €
63-40	GF-753901657	16,50 €	PLA-REP063040C	14,52 €
63-50	GF-753901658	16,50 €	PLA-REP063050C	14,52 €
75-63			PLA-REP075063C	18,48 €
90-63	GF-753901831	27,94 €	PLA-REP090063C	24,86 €
90-75			PLA-REP090075C	24,86 €
110-63	GF-753901832	41,80 €		
110-75			PLA-REP110075C	37,62 €
110-90	GF-753901833	41,80 €	PLA-REP110090C	37,62 €
125-90	GF-753901836	53,02 €		
125-110			PLA-REP125110C	47,30 €
140-90			PLA-REP140090C	48,84 €
160-90	GF-753901839	58,08 €		
160-110	GF-753901864	58,08 €	PLA-REP160110C	51,48 €
180-125	GF-753901865	86,24 €	PLA-REP180125C	51,48 €
200-160	GF-753901837	362,12 €	PLA-REP200160C	217,80 €
225-160	GF-753901838	445,06 €	PLA-REP225160C	267,74 €
250-160	GF-753901840	538,12 €		
250-200	GF-753901841	538,12 €		

GAZ WODA KANALIZACJA 

Taping Tee Monobloc PE100 SDR11

+GF+

d-d1	Price
32-20	24,86 €
40-20	48,18 €
40-25	48,18 €
40-32	48,18 €
50-20	52,80 €
50-25	52,80 €
50-32	52,80 €



Electrofusion saddle PE100 SDR11

+GF+

d-d1	Price
63-63	22,66 €
75-63	25,96 €
90-63	26,18 €
110-63	31,02 €
125-63	37,62 €
140-63	53,68 €
160-63	60,50 €
180-63	65,34 €
200-63	80,30 €
225-63	86,68 €
250-63	128,70 €
280-63*	128,70 €
315/355-63*	133,54 €
400-63*	133,54 €

*



Taping tee PE100 SDR11

+GF+

d-d1	Price
63-20	20,90 €
63-25	20,90 €
63-32	20,90 €
63-40	24,42 €
63-63	24,42 €
63-63*	24,42 €

* With Saddle ELGEF Plus DN 250+315 SDR 11 and DN 250+400 SDR 17



Tapping valve PE100 SDR11

+GF+

d-d1	Price
63-32	159,94 €
63-63	159,94 €

GAZ WODA KANALIZACJA 

Electrofusion cap PE100 SDR11

+GF+

d	Price
20	8,14 €
25	8,58 €
32	9,90 €
40	10,78 €
50	16,72 €
63	18,04 €



Electrofusion cap PE100 SDR11 SET

+GF+

d	Price
75	29,26 €
90	38,28 €
110	49,28 €
125	59,84 €
140	75,24 €
160	85,58 €
180	105,82 €
200	136,18 €
225	165,66 €



Saddle SATURN PE100 SDR11

+GF+

d-d1	Price
110-90	184,80 €
110-110	193,16 €
125-90	225,94 €
125-110	234,52 €
140-90*	252,56 €
140-110*	261,36 €
160-90	252,56 €
160-110	261,36 €
160-125	269,50 €
180-90	263,34 €
180-110	272,36 €
180-125	280,94 €
200-90	272,14 €
200-110	280,28 €
200-125	288,42 €
225-90	283,58 €
225-110	294,36 €
225-125	303,60 €
250-90	301,40 €
250-110	311,52 €
250-125	321,86 €

GAZ WODA KANALIZACJA 

Saddle TOPLOAD PE100 SDR11

+GF+

d-d1	Price
280-90	448,14 €
280-110	448,14 €
280-125	448,14 €
315/355-90	489,06 €
315/355-110	489,06 €
315/355-125	489,06 €
400-90	489,06 €
400-110	489,06 €
400-125	489,06 €
450-90	489,06 €
450-110	489,06 €
450-125	489,06 €
500/630-90	570,68 €
500/630-110	570,68 €
500/630-125	570,68 €



Saddle TOPLOAD PE100 SDR11

+GF+

d-d1	Price
315-160	1 301,52 €
315-225	1 497,54 €
355-160	1 560,68 €
355-225	1 795,64 €
400-160	1 690,48 €
400-225	1 946,56 €
450-160	1 822,92 €
450-225	2 094,18 €
500-160	1 952,50 €
500-225	2 244,88 €
560-160	2 082,08 €
560-225	2 395,36 €
630-160	2 211,44 €
630-225	2 542,98 €
710-160	2 536,82 €
710-225	2 916,54 €
800-160	2 928,64 €
800-225	3 365,78 €
900-225	3 579,18 €
1000-225	4 227,30 €

GAZ WODA KANALIZACJA 

Saddle TOPLOAD PE100 SDR11

+GF+

d-d1	Price
500-315	on request
560-315	on request
630-315	on request
710-315	on request
800-315	on request
900-315	on request
1000-315	on request



Saddle TOPLOAD PE100 SDR11

+GF+

d-d1	Price
710-315	on request
800-315	on request
900-315	on request
1000-315	on request
1200-315	on request
1400-315	on request
1600-315	on request
2000-315	on request

GAZ WODA KANALIZACJA 

Transition fitting MALE PE100 SDR11

+GF+

d-R	Code	Price Net	Code	Price Net
20-1/2"	GF-720920706	27,50 €		
25-3/4"	GF-720920707	27,50 €	PLA-RTOMP025C	19,14 €
32-1"	GF-720920708	27,50 €	PLA-RTOMP032C	22,66 €
32-1 1/4"	GF-720920718	40,92 €		
32-1 1/2"	GF-720920728	57,20 €		
40-1"	GF-720920719	42,46 €		
40-1 1/4"	GF-720920709	32,34 €	PLA-RTOMP040C	27,72 €
40-1 1/2"	GF-720920729	42,46 €		
50-1"	GF-720920720	44,00 €		
50-1 1/4"	GF-720920730	44,00 €		
50-1 1/2"	GF-720920710	42,46 €	PLA-RTOMP050C	36,52 €
63-1 1/4"	GF-720920721	57,20 €		
63-1 1/2"	GF-720920731	57,20 €		
63-2"	GF-720920711	49,72 €	PLA-RTOMP063C	47,08 €
75-2 1/2"			PLA-RTOMP075C	96,36 €
90-3"			PLA-RTOMP090C	135,96 €
110-4"			PLA-RTOMP110C	178,64 €



Transition fitting FEMALE PE100 SDR11

+GF+

d-R	Code	Price Net	Code	Price Net
25-3/4"			PLA-RTOFP025C	18,70 €
32-1"	GF-720920208	34,98 €	PLA-RTOFP032C	25,74 €
40-1 1/4"	GF-720920209	40,04 €	PLA-RTOFP040C	31,46 €
50-1 1/2"	GF-720920210	41,36 €	PLA-RTOFP050C	40,48 €
63-1"	GF-720920221	62,04 €		
63-1 1/4"	GF-720920231	62,04 €		
63-1 1/2"	GF-720920241	62,04 €		
63-2"	GF-720920211	54,56 €	PLA-RTOFP063C	46,42 €
75-2 1/2"			PLA-RTOFP075C	78,76 €
90-3"			PLA-RTOFP090C	102,08 €



Stop-off adaptor PE100 SDR11

+GF+

d-Rp	Price
63-6/4"	78,10 €

GAZ WODA KANALIZACJA 

PE Ball Valve PE100 SDR11

+GF+

d	Price
20	97,90 €
25	97,90 €
32	97,90 €
40	97,90 €
50	165,66 €
63	165,66 €
75	291,50 €
90	275,22 €
110	360,14 €
125	349,36 €
160	872,08 €
180	1 019,70 €
200	1 019,70 €
225	2 902,24 €



PE Ball Valve full bore

+GF+

d	Price
110	on request
160	on request



Injection elbow long 90° PE100 SDR11



GAS / WATER / SEWERS



WODA / SEWERS

d	Code	Price Net	Code	Price Net
20	GF-753101006	3,08 €		
25	GF-753101007	3,52 €		
32	GF-753101008	4,18 €		
40	GF-753101009	5,50 €		
50	GF-753101010	6,38 €		
63	GF-753101011	10,56 €	BOR-K/11-63/90	5,28 €
75	GF-753101012	14,74 €	BOR-K/11-75/90	8,80 €
90	GF-753101013	17,16 €	BOR-K/11-90/90	11,88 €
110	GF-753101014	29,26 €	BOR-K/11-110/90	19,80 €
125	GF-753101015	39,38 €	BOR-K/11-125/90	27,94 €
140	GF-753101016	43,56 €	BOR-K/11-140/90	38,28 €
160	GF-753101017	57,64 €	BOR-K/11-160/90	44,00 €
180	GF-753101018	65,12 €	BOR-K/11-180/90	57,20 €
200	GF-753101019	89,32 €	BOR-K/11-200/90	81,18 €
225	GF-753101020	106,26 €	BOR-K/11-225/90	97,90 €
250	GF-753101001	184,36 €	BOR-K/11-250/90	147,40 €
280	GF-753100922	296,56 €	BOR-K/11-280/90	215,60 €
315	GF-753100923	419,76 €	BOR-K/11-315/90	260,92 €
355			BOR-K/11-355/90	494,34 €
400			BOR-K/11-400/90	728,42 €
450			BOR-K/11-450/90	1 079,98 €
500			BOR-K/11-500/90	1 480,38 €
560			BOR-K/11-560/90	1 662,10 €
630			BOR-K/11-630/90	2 258,74 €



Injection elbow long 45° PE100 SDR11



GAS / WATER / SEWERS



WODA / SEWERS

d	Code	Price Net	Code	Price Net
20	GF-753151006	2,64 €		
25	GF-753151007	3,08 €		
32	GF-753151008	4,18 €		
40	GF-753151009	5,50 €		
50	GF-753151010	6,38 €		
63	GF-753151011	10,56 €	BOR-K/11-63/45	5,28 €
75	GF-753151012	14,74 €	BOR-K/11-75/45	8,80 €
90	GF-753151013	17,16 €	BOR-K/11-90/45	11,88 €
110	GF-753151014	25,96 €	BOR-K/11-110/45	19,80 €
125	GF-753151015	39,38 €	BOR-K/11-125/45	27,94 €
140	GF-753151016	43,56 €	BOR-K/11-140/45	38,28 €
160	GF-753151017	57,64 €	BOR-K/11-160/45	44,00 €
180	GF-753151018	65,12 €	BOR-K/11-180/45	57,20 €
200	GF-753151019	89,32 €	BOR-K/11-200/45	67,98 €
225	GF-753151020	106,26 €	BOR-K/11-225/45	87,78 €
250	GF-753151021	184,36 €	BOR-K/11-250/45	147,40 €
280	GF-753150922	277,64 €	BOR-K/11-280/45	215,60 €
315	GF-753150923	337,48 €	BOR-K/11-315/45	260,92 €
355			BOR-K/11-355/45	494,34 €
400			BOR-K/11-400/45	728,42 €
450			BOR-K/11-450/45	777,04 €
500			BOR-K/11-500/45	1 061,28 €
560			BOR-K/11-560/45	on request
630			BOR-K/11-630/45	on request

GAZ WODA KANALIZACJA 

Injection elbow long 90° PE100 SDR17

+GF+

GAS / WATER / SEWERS

TURAN (BORFIT)

WODA / SEWERS

d	Code	Price Net	Code	Price Net
90	GF-753100813	14,74 €	BOR-K/17-090/90	11,00 €
110	GF-753100814	27,94 €	BOR-K/17-110/90	17,82 €
125	GF-753100815	35,64 €	BOR-K/17-125/90	27,50 €
140	GF-753100816	43,34 €	BOR-K/17-140/90	36,52 €
160	GF-753100817	51,70 €	BOR-K/17-160/90	39,38 €
180	GF-753100818	58,52 €	BOR-K/17-180/90	52,80 €
200	GF-753100819	79,86 €	BOR-K/17-200/90	69,74 €
225	GF-753100820	96,14 €	BOR-K/17-225/90	79,20 €
250	GF-753100821	157,96 €	BOR-K/17-250/90	125,84 €
280	GF-753100822	238,04 €	BOR-K/17-280/90	190,52 €
315	GF-753100823	297,44 €	BOR-K/17-315/90	236,50 €
355			BOR-K/17-355/90	353,32 €
400			BOR-K/17-400/90	495,66 €
450			BOR-K/17-450/90	777,04 €
500			BOR-K/17-500/90	1 061,28 €
560			BOR-K/17-560/90	1 180,08 €
630			BOR-K/17-630/90	1 404,48 €



Injection elbow long 45° PE100 SDR17

+GF+

GAS / WATER / SEWERS

TURAN (BORFIT)

WODA / SEWERS

d	Code	Price Net	Code	Price Net
90	GF-753150813	14,74 €		
110	GF-753150814	23,98 €	BOR-K/17-110/45	17,82 €
125	GF-753150815	35,64 €	BOR-K/17-125/45	27,50 €
140	GF-753150816	43,34 €	BOR-K/17-140/45	36,52 €
160	GF-753150817	51,70 €	BOR-K/17-160/45	39,38 €
180	GF-753150818	58,52 €	BOR-K/17-180/45	52,80 €
200	GF-753150819	79,86 €	BOR-K/17-200/45	62,04 €
225	GF-753150820	96,14 €	BOR-K/17-225/45	72,16 €
250	GF-753150821	157,96 €	BOR-K/17-250/45	125,84 €
280	GF-753150822	239,14 €	BOR-K/17-280/45	190,52 €
315	GF-753150823	297,44 €	BOR-K/17-315/45	236,50 €
355			BOR-K/17-355/45	353,32 €
400			BOR-K/17-400/45	495,66 €
450			BOR-K/17-450/45	777,04 €
500			BOR-K/17-500/45	1 061,28 €
560			BOR-K/17-560/45	1 180,08 €
630			BOR-K/17-630/45	1 404,48 €

GAZ WODA KANALIZACJA 

Injection End Cap long PE100 SDR11

+GF+

GAS / WATER / SEWERS

TURAN BORFIT

WODA / SEWERS

d	Code	Price Net	Code	Price Net
20	GF-753800006	2,64 €		
25	GF-753800007	3,08 €		
32	GF-753800008	3,74 €		
40	GF-753800009	4,40 €		
50	GF-753800010	6,16 €		
63	GF-753800011	7,48 €	BOR-Z/11-63	3,74 €
75	GF-753800012	14,08 €	BOR-Z/11-75	5,72 €
90	GF-753800013	17,82 €	BOR-Z/11-90	8,14 €
110	GF-753800014	21,56 €	BOR-Z/11-110	10,56 €
125	GF-753800015	24,20 €	BOR-Z/11-125	12,76 €
140	GF-753800016	32,56 €	BOR-Z/11-140	17,38 €
160	GF-753800017	33,66 €	BOR-Z/11-160	19,36 €
180	GF-753800018	47,08 €	BOR-Z/11-180	27,72 €
200	GF-753800019	58,96 €	BOR-Z/11-200	32,56 €
225	GF-753800020	70,18 €	BOR-Z/11-225	37,18 €
250	GF-753800021	89,76 €	BOR-Z/11-250	86,68 €
280	GF-753800022	127,16 €	BOR-Z/11-280	119,68 €
315	GF-753800023	172,26 €	BOR-Z/11-315	162,80 €
355	GF-753800224	386,10 €	BOR-Z/11-355	214,94 €
400	GF-753960925	681,56 €	BOR-Z/11-400	293,92 €
450	GF-753960926	on request		
500	GF-753960927	on request		
560	GF-753960928	on request		
630	GF-753960929	on request		



Injection End Cap long PE100 SDR17

+GF+

d	Price
50	7,92 €
63	8,58 €
75	14,08 €
90	17,82 €
110	22,44 €
125	25,96 €
140	32,56 €
160	33,66 €
180	47,08 €
200	58,52 €
225	69,96 €
250	81,84 €
280	115,50 €
315	157,96 €
355	386,10 €
400	681,56 €
450	on request
500	on request
560	on request
630	on request



GAZ 

WODA 

KANALIZACJA 

Bend 90° PE100 SDR11, SDR17

+GF+

SDR11			SDR17	
d	Code	Price Net	Code	Price Net
32	GF-753001008	4,84 €		
40	GF-753001009	6,38 €		
50	GF-753001010	8,58 €		
63	GF-753001011	19,14 €		
75	GF-753001012	23,32 €		
90	GF-753001013	24,20 €	GF-753000813	32,56 €
110	GF-753001014	39,38 €	GF-753000814	40,48 €
125	GF-753001015	57,86 €	GF-753000815	46,86 €
140	GF-753001016	89,32 €	GF-753000816	53,68 €
160	GF-753001017	93,28 €	GF-753000817	60,94 €
180	GF-753001018	117,26 €	GF-753000818	97,46 €
200	GF-753001019	123,64 €	GF-753000819	117,04 €
225	GF-753001020	163,90 €	GF-753000820	138,16 €
250	GF-753001021	254,76 €	GF-753000821	228,80 €
280	GF-753001022	330,44 €	GF-753000822	297,44 €
315	GF-753001023	457,16 €	GF-753000823	411,18 €
355*	GF-753001024	1 092,74 €	GF-753000824	726,66 €
400*	GF-753001025	1 253,34 €	GF-753000825	1 021,24 €
450*	GF-753001026	1 775,62 €	GF-753000826	1 449,58 €
500*	GF-753001027	2 669,48 €	GF-753000827	2 077,68 €
560*	GF-753001028	3 333,66 €	GF-753000828	2 584,78 €
630*	GF-753001029	4 300,12 €	GF-753000829	3 213,54 €

* seamless bend PE100

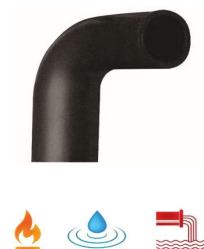

Bend 60° PE100 SDR11, SDR17

+GF+

SDR11			SDR17	
d	Code	Price Net	Code	Price Net
32	GF-753071008	36,96 €		
40	GF-753071009	40,26 €		
50	GF-753071010	55,88 €		
63	GF-753071011	78,32 €		
75	GF-753071012	86,02 €		
90	GF-753071013	96,14 €	GF-753070813	78,32 €
110	GF-753071014	109,78 €	GF-753070814	98,78 €
125	GF-753071015	141,02 €	GF-753070815	112,42 €
140	GF-753071016	159,50 €	GF-753070816	128,70 €
160	GF-753071017	188,98 €	GF-753070817	144,10 €
180	GF-753071018	311,96 €	GF-753070818	228,36 €
200	GF-753071019	377,74 €	GF-753070819	274,78 €
225	GF-753071020	447,92 €	GF-753070820	323,84 €
250	GF-753071021	540,32 €	GF-753070821	405,02 €
280	GF-753071022	649,00 €	GF-753070822	452,76 €
315	GF-753071023	798,16 €	GF-753070823	588,28 €
355	GF-753071024	1 254,44 €	GF-753070824	799,70 €
400	GF-753071025	1 384,02 €	GF-753070825	1 142,02 €
450	GF-753071026	1 701,92 €	GF-753070826	1 389,08 €
500	GF-753071027	2 559,70 €	GF-753070827	1 993,64 €
560	GF-753071028	3 204,30 €	GF-753070828	2 473,90 €
630	GF-753071029	4 118,18 €	GF-753070829	3 085,06 €

GAZ WODA KANALIZACJA 

Bend 45° PE100 SDR11, SDR17

+GF+

SDR11			SDR17	
d	Code	Price Net	Code	Price Net
32	GF-753051008	36,96 €		
40	GF-753051009	40,26 €		
50	GF-753051010	55,00 €		
63	GF-753051011	77,22 €		
75	GF-753051012	84,26 €		
90	GF-753051013	93,72 €	GF-753050813	77,00 €
110	GF-753051014	121,44 €	GF-753050814	96,36 €
125	GF-753051015	135,30 €	GF-753050815	109,12 €
140	GF-753051016	152,24 €	GF-753050816	124,30 €
160	GF-753051017	178,42 €	GF-753050817	136,84 €
180	GF-753051018	298,98 €	GF-753050818	219,34 €
200	GF-753051019	362,56 €	GF-753050819	265,10 €
225	GF-753051020	432,74 €	GF-753050820	313,94 €
250	GF-753051021	504,02 €	GF-753050821	380,16 €
280	GF-753051022	599,06 €	GF-753050822	420,42 €
315	GF-753051023	726,66 €	GF-753050823	542,08 €
355	GF-753051024	1 228,70 €	GF-753050824	792,44 €
400	GF-753051025	1 351,46 €	GF-753050825	1 099,34 €
450	GF-753051026	1 661,22 €	GF-753050826	1 321,76 €
500	GF-753051027	2 326,72 €	GF-753050827	1 812,58 €
560	GF-753051028	2 912,80 €	GF-753050828	2 248,62 €
630	GF-753051029	3 743,74 €	GF-753050829	2 804,78 €



Bend 30° PE100 SDR11, SDR17

+GF+

SDR11			SDR17	
d	Code	Price Net	Code	Price Net
32	GF-753061008	36,96 €		
40	GF-753061009	40,26 €		
50	GF-753061010	55,00 €		
63	GF-753061011	77,22 €		
75	GF-753061012	84,26 €		
90	GF-753061013	93,72 €	GF-753060813	77,00 €
110	GF-753061014	121,44 €	GF-753060814	96,36 €
125	GF-753061015	135,30 €	GF-753060815	109,12 €
140	GF-753061016	152,24 €	GF-753060816	124,30 €
160	GF-753061017	178,42 €	GF-753060817	136,84 €
180	GF-753061018	298,98 €	GF-753060818	219,34 €
200	GF-753061019	362,56 €	GF-753060819	265,10 €
225	GF-753061020	432,74 €	GF-753060820	313,94 €
250	GF-753061021	504,02 €	GF-753060821	380,16 €
280	GF-753061022	599,06 €	GF-753060822	420,42 €
315	GF-753061023	726,66 €	GF-753060823	542,08 €
355	GF-753061024	1 228,70 €	GF-753060824	792,44 €
400	GF-753061025	1 351,46 €	GF-753060825	1 099,34 €
450	GF-753061026	1 661,22 €	GF-753060826	1 321,76 €
500	GF-753061027	2 326,72 €	GF-753060827	1 812,58 €
560	GF-753061028	2 912,80 €	GF-753060828	2 248,62 €
630	GF-753061029	3 743,74 €	GF-753060829	2 804,78 €

GAZ WODA KANALIZACJA 

Bend 22° PE100 SDR11, SDR17

+GF+

SDR11			SDR17	
d	Code	Price Net	Code	Price Net
32	GF-753081008	36,96 €		
40	GF-753081009	40,26 €		
50	GF-753081010	55,00 €		
63	GF-753081011	77,22 €		
75	GF-753081012	84,26 €		
90	GF-753081013	93,72 €	GF-753080813	77,00 €
110	GF-753081014	121,44 €	GF-753080814	96,36 €
125	GF-753081015	135,30 €	GF-753080815	109,12 €
140	GF-753081016	152,24 €	GF-753080816	124,30 €
160	GF-753081017	178,42 €	GF-753080817	136,84 €
180	GF-753081018	298,98 €	GF-753080818	219,34 €
200	GF-753081019	362,56 €	GF-753080819	265,10 €
225	GF-753081020	432,74 €	GF-753080820	313,94 €
250	GF-753081021	504,02 €	GF-753080821	380,16 €
280	GF-753081022	599,06 €	GF-753080822	420,42 €
315	GF-753081023	726,66 €	GF-753080823	542,08 €
355	GF-753081024	1 228,70 €	GF-753080824	792,44 €
400	GF-753081025	1 351,46 €	GF-753080825	1 099,34 €
450	GF-753081026	1 661,22 €	GF-753080826	1 321,76 €
500	GF-753081027	2 326,72 €	GF-753080827	1 812,58 €
560	GF-753081028	2 912,80 €	GF-753080828	2 248,62 €
630	GF-753081029	3 743,74 €	GF-753080829	2 804,78 €



Bend 11° PE100 SDR11, SDR17

+GF+

SDR11			SDR17	
d	Code	Price Net	Code	Price Net
32	GF-753091008	36,96 €		
40	GF-753091009	40,26 €		
50	GF-753091010	55,00 €		
63	GF-753091011	77,22 €		
75	GF-753091012	84,26 €		
90	GF-753091013	93,72 €	GF-753090813	77,00 €
110	GF-753091014	121,44 €	GF-753090814	96,36 €
125	GF-753091015	135,30 €	GF-753090815	109,12 €
140	GF-753091016	152,24 €	GF-753090816	124,30 €
160	GF-753091017	178,42 €	GF-753090817	136,84 €
180	GF-753091018	298,98 €	GF-753090818	219,34 €
200	GF-753091019	362,56 €	GF-753090819	265,10 €
225	GF-753091020	432,74 €	GF-753090820	313,94 €
250	GF-753091021	504,02 €	GF-753090821	380,16 €
280	GF-753091022	599,06 €	GF-753090822	420,42 €
315	GF-753091023	726,66 €	GF-753090823	542,08 €
355	GF-753091024	1 228,70 €	GF-753090824	792,44 €
400	GF-753091025	1 351,46 €	GF-753090825	1 099,34 €
450	GF-753091026	1 661,22 €	GF-753090826	1 321,76 €
500	GF-753091027	2 326,72 €	GF-753090827	1 812,58 €
560	GF-753091028	2 912,80 €	GF-753090828	2 248,62 €
630	GF-753091029	3 743,74 €	GF-753090829	2 804,78 €

GAZ WODA KANALIZACJA 

Injecion tee 90° long PE100 SDR11

+GF+

GAS / WATER / SEWERS

TURAN (BORFIT)

WODA / SEWERS

d	Code	Price Net	Code	Price Net
20	GF-753201006	3,52 €		
25	GF-753201007	3,96 €		
32	GF-753201008	4,40 €		
40	GF-753201009	6,16 €		
50	GF-753201010	7,70 €		
63	GF-753201011	10,12 €		
75	GF-753201012	16,06 €		
90	GF-753201013	24,20 €	BOR-T/11-090	15,84 €
110	GF-753201014	33,22 €	BOR-T/11-110	22,66 €
125	GF-753201015	49,28 €	BOR-T/11-125	34,54 €
140	GF-753201016	74,36 €	BOR-T/11-140	50,16 €
160	GF-753201017	86,46 €	BOR-T/11-160	63,58 €
180	GF-753201018	119,68 €	BOR-T/11-180	95,26 €
200	GF-753201019	176,00 €	BOR-T/11-200	117,26 €
225	GF-753201020	208,78 €	BOR-T/11-225	150,92 €
250	GF-753201001	296,12 €	BOR-T/11-250	220,88 €
280	GF-753201902	380,60 €	BOR-T/11-280	302,50 €
315	GF-753201903	568,70 €	BOR-T/11-315	394,02 €
355	GF-753200024	682,00 €	BOR-T/11-355	649,00 €
400	GF-753200025	1 012,00 €	BOR-T/11-400	957,00 €
450	GF-753200026	1 518,00 €	BOR-T/11-450	1 441,00 €
500	GF-753200027	1 650,00 €	BOR-T/11-500	1 562,00 €
560	GF-753200028	5 060,00 €	BOR-T/11-560	on request
630	GF-753200029	6 820,00 €	BOR-T/11-630	on request

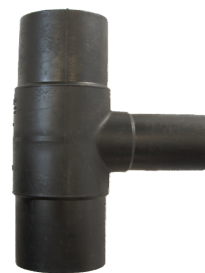

Injecion tee 90° long PE100 SDR17

+GF+

GAS / WATER / SEWERS

TURAN (BORFIT)

WODA / SEWERS

d	Code	Price Net	Code	Price Net
90	GF-753200813	21,12 €	BOR-T/17-090	14,08 €
110	GF-753200814	29,92 €	BOR-T/17-110	20,68 €
125	GF-753200815	41,58 €	BOR-T/17-125	31,24 €
140	GF-753200816	63,80 €	BOR-T/17-140	45,76 €
160	GF-753200817	73,92 €	BOR-T/17-160	57,20 €
180	GF-753200818	104,06 €	BOR-T/17-180	78,32 €
200	GF-753200819	148,50 €	BOR-T/17-200	99,00 €
225	GF-753200820	177,32 €	BOR-T/17-225	130,46 €
250	GF-753200821	223,96 €	BOR-T/17-250	170,28 €
280	GF-753200802	339,24 €	BOR-T/17-280	258,06 €
315	GF-753200803	434,06 €	BOR-T/17-315	329,34 €
355	GF-753200124	649,00 €	BOR-T/17-355	616,00 €
400	GF-753200125	748,00 €	BOR-T/17-400	704,00 €
450	GF-753200126	1 056,00 €	BOR-T/17-450	990,00 €
500	GF-753200127	1 309,00 €	BOR-T/17-500	1 232,00 €
560	GF-753200128	3 696,00 €	BOR-T/17-560	1 848,00 €
630	GF-753200129	5 280,00 €	BOR-T/17-630	2 640,00 €

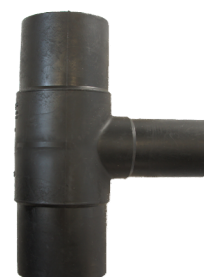
GAZ WODA KANALIZACJA 

Injecion tee 45° long PE100 SDR11

+GF+

GAS / WATER / SEWERS

TURAN BORFIT

WODA / SEWERS

d	Code	Price Net	Code	Price Net
63	GF-753251011	61,16 €		
75	GF-753251012	92,84 €		
90	GF-753251013	144,10 €		
110	GF-753251014	204,16 €	BOR-TK/11-110-45	83,82 €
160			BOR-TK/11-160-45	141,46 €



Injestion reduced tee 90° long PE100 SDR11

+GF+

GAS / WATER / SEWERS

TURAN BORFIT

WODA / SEWERS

d-d1	Code	Price Net	Code	Price Net
63-50	GF-753201021	19,00 €		
75-32	GF-753201023	30,87 €		
75-50	GF-753201024	30,87 €		
75-63	GF-753201025	30,87 €		
90-50	GF-753201027	42,48 €		
90-63	GF-753201029	46,86 €	BOR-TR/11-90/63	17,60 €
90-75	GF-753201030	46,86 €		
110-63	GF-753201028	68,64 €	BOR-TR/11-110/63	26,18 €
110-75	GF-753201031	73,04 €		
110-90	GF-753201032	86,46 €	BOR-TR/11-110/90	26,18 €
125-90	GF-753201048	94,82 €	BOR-TR/11-125/90	44,66 €
125-110	GF-753201033	94,82 €	BOR-TR/11-125/110	44,66 €
160-63	GF-753201034	188,76 €	BOR-TR/11-160/63	44,66 €
160-75	GF-753201035	188,76 €		
160-90	GF-753201036	194,04 €	BOR-TR/11-160/90	72,60 €
160-110	GF-753201037	269,28 €	BOR-TR/11-160/110	72,60 €
180-90	GF-753201049	269,28 €	BOR-TR/11-180/90	121,22 €
180-110	GF-753201050	269,28 €	BOR-TR/11-180/110	121,22 €
180-160	GF-753201038	401,06 €		
200-63	GF-753201073	392,04 €	BOR-TR/11-200/63	162,80 €
200-90	GF-753201074	402,38 €	BOR-TR/11-200/90	162,80 €
200-110	GF-753201075	412,72 €	BOR-TR/11-200/110	162,80 €
200-160	GF-753201076	436,92 €	BOR-TR/11-200/160	162,80 €
225-75	GF-753201039	444,18 €		
225-90	GF-753201040	444,18 €	BOR-TR/11-225/90	172,70 €
225-110	GF-753201041	754,16 €	BOR-TR/11-225/110	172,70 €
225-160	GF-753201042	754,16 €	BOR-TR/11-225/160	172,70 €
225-180	GF-753201043	720,72 €		
250-110	GF-753201078	720,72 €		
250-160	GF-753201079	754,16 €		
250-200			BOR-TR/11-250/200	330,88 €
280-110			BOR-TR/11-280/110	374,00 €
280-160			BOR-TR/11-280/160	374,00 €
280-200			BOR-TR/11-280/200	465,52 €
315-110	GF-753201051	720,72 €	BOR-TR/11-315/110	538,78 €
315-160	GF-753201052	720,72 €	BOR-TR/11-315/160	538,78 €
315-200			BOR-TR/11-315/200	538,78 €
315-225	GF-753201053	754,16 €		
315-250	GF-753201054	754,16 €	BOR-TR/11-315/250	538,78 €



GAZ 

WODA 

KANALIZACJA 

Injecion tee 45° long PE100 SDR17

+GF+

GAS / WATER / SEWERS

TURAN BORFIT

WODA / SEWERS

d	Code	Price Net	Code	Price Net
90	GF-753251063	138,60 €		
110	GF-753251064	196,90 €	BOR-TK/17-110-45	66,44 €
160			BOR-TK/17-160-45	112,86 €



Injestion reduced tee 90° long PE100 SDR17

+GF+

GAS / WATER / SEWERS

TURAN BORFIT

WODA / SEWERS

d-d1	Code	Price Net	Code	Price Net
90-50	GF-753201827	38,52 €		
90-63	GF-753201829	39,31 €		
90-75	GF-753201830	39,31 €		
110-63	GF-853201828	57,78 €		
110-75	GF-753201831	61,16 €		
110-90	GF-753201832	71,94 €	BOR-TR/17-110/90	23,76 €
125-110	GF-753200833	78,76 €		
160-63	GF-753200834	84,70 €	BOR-TR/17-160/63	65,78 €
160-75	GF-753200835	168,52 €		
160-90	GF-753200836	174,24 €	BOR-TR/17-160/90	65,78 €
160-110	GF-753200837	175,78 €	BOR-TR/17-160/110	65,78 €
180-90	GF-753200844	234,74 €		
180-110			BOR-TR/17-180/110	110,66 €
180-160	GF-753200838	234,74 €		
200-63	GF-753201873	334,84 €		
200-90	GF-753201874	336,38 €	BOR-TR/17-200/90	148,28 €
200-110	GF-753201875	338,80 €	BOR-TR/17-200/110	148,28 €
200-160	GF-753201876	340,34 €	BOR-TR/17-200/160	148,28 €
225-75	GF-753200839	394,46 €		
225-90	GF-753200840	394,46 €	BOR-TR/17-225/90	184,14 €
225-110	GF-753200841	397,10 €	BOR-TR/17-225/110	184,14 €
225-160	GF-753200842	397,54 €	BOR-TR/17-225/160	184,14 €
225-180	GF-753200843	399,08 €		
250-90			BOR-TR/17-250/90	300,74 €
250-110	GF-753201878	540,98 €	BOR-TR/17-250/110	300,74 €
250-160	GF-753201879	550,88 €	BOR-TR/17-250/160	300,74 €
250-200			BOR-TR/17-250/200	300,74 €
280-110			BOR-TR/17-280/110	300,74 €
280-160			BOR-TR/17-280/160	336,16 €
280-200			BOR-TR/17-280/200	394,24 €
315-110	GF-753200851	663,30 €	BOR-TR/17-315/110	495,88 €
315-160	GF-753200852	663,30 €	BOR-TR/17-315/160	495,88 €
315-200			BOR-TR/17-315/200	495,88 €
315-225	GF-753200853	693,44 €		
315-250	GF-753200854	693,44 €	BOR-TR/17-315/250	495,88 €

GAZ WODA KANALIZACJA 

Injection reducer long PE100 SDR11



GAS / WATER / SEWERS



WODA / SEWERS

d-d1	Code	Price Net	Code	Price Net
25-20	GF-753901038	2,20 €		
32-20	GF-753901042	2,20 €		
32-25	GF-753901041	2,20 €		
40-20	GF-753901048	3,52 €		
40-25	GF-753901047	3,52 €		
40-32	GF-753901046	3,52 €		
50-25	GF-753901054	4,18 €		
50-32	GF-753901053	4,18 €		
50-40	GF-753901052	4,18 €		
63-32	GF-753901060	6,16 €		
63-40	GF-753901059	6,16 €		
63-50	GF-753901058	6,16 €		
75-50	GF-753901064	9,24 €		
75-63	GF-753901065	9,24 €		
90-50	GF-753901072	12,54 €		
90-63	GF-753901071	12,54 €	BOR-R/11-90-63	6,82 €
90-75	GF-753901070	12,54 €	BOR-R/11-90-75	6,82 €
110-63	GF-753901078	16,94 €	BOR-R/11-110-63	10,56 €
110-75	GF-753901077	16,94 €	BOR-R/11-110-75	10,56 €
110-90	GF-753901076	16,94 €	BOR-R/11-110-90	10,56 €
125-63	GF-753901083	18,92 €	BOR-R/11-125-63	16,28 €
125-75	GF-753901082	19,58 €	BOR-R/11-125-75	16,28 €
125-90	GF-753901081	19,58 €	BOR-R/11-125-90	16,28 €
125-110	GF-753901080	19,58 €	BOR-R/11-125-110	16,28 €
140-75	GF-753901086	29,92 €	BOR-R/11-140-75	25,08 €
140-90	GF-753901087	29,92 €	BOR-R/11-140-90	25,08 €
140-110	GF-753901084	29,92 €	BOR-R/11-140-110	25,08 €
140-125	GF-753901085	28,16 €	BOR-R/11-140-125	22,22 €
160-90	GF-753901088	38,06 €	BOR-R/11-160-90	25,08 €
160-110	GF-753901090	38,06 €	BOR-R/11-160-110	20,24 €
160-125	GF-753901089	38,06 €	BOR-R/11-160-125	20,24 €
160-140	GF-753901032	38,06 €	BOR-R/11-160-140	20,24 €
180-90	GF-753901073	44,44 €	BOR-R/11-180-90	29,04 €
180-110	GF-753901074	44,44 €	BOR-R/11-180-110	29,04 €
180-125	GF-753901091	48,40 €	BOR-R/11-180-125	40,70 €
180-140	GF-753901075	48,40 €	BOR-R/11-180-140	40,70 €
180-160	GF-753901033	46,20 €	BOR-R/11-180-160	40,70 €
200-140	GF-753901066	56,54 €	BOR-R/11-200-140	41,80 €
200-160	GF-753901092	53,68 €	BOR-R/11-200-160	41,80 €
200-180	GF-753901034	53,68 €	BOR-R/11-200-180	44,00 €
225-110			BOR-R/11-225-110	44,00 €
225-140	GF-753901067	90,42 €		52,36 €
225-160	GF-753901096	86,46 €	BOR-R/11-225-160	52,36 €
225-180	GF-753901095	86,46 €		
225-200	GF-753901094	86,46 €	BOR-R/11-225-200	55,88 €
250-125			BOR-R/11-250-125	80,30 €
250-160	GF-753901000	128,26 €	BOR-R/11-250-160	80,30 €
250-180	GF-753901068	140,80 €	BOR-R/11-250-180	80,30 €
250-200	GF-753901001	134,20 €	BOR-R/11-250-200	91,08 €
250-225	GF-753901002	134,20 €	BOR-R/11-250-225	91,08 €
280-200	GF-753901098	176,66 €	BOR-R/11-280-200	123,86 €
280-225	GF-753901099	176,66 €	BOR-R/11-280-225	123,86 €
280-250	GF-753901003	160,16 €	BOR-R/11-280-250	123,86 €

GAZ WODA KANALIZACJA 

Injection reducer long PE100 SDR11



GAS / WATER / SEWERS



WODA / SEWERS

d-d1	Code	Price Net	Code	Price Net
315-160			BOR-R/11-315-160	177,98 €
315-200	GF-753901004	229,68 €	BOR-R/11-315-200	177,98 €
315-225	GF-753901097	229,68 €	BOR-R/11-315-225	177,98 €
315-250	GF-753901005	229,68 €	BOR-R/11-315-250	182,16 €
315-280	GF-753901012	231,44 €	BOR-R/11-315-280	224,18 €
355-200			BOR-R/11-355-200	415,58 €
355-250	GF-753901013	709,06 €	BOR-R/11-355-250	444,18 €
355-280	GF-753901014	652,96 €		
355-315	GF-753901015	632,06 €	BOR-R/11-355-315	523,16 €
400-200			BOR-R/11-355-315	498,52 €
400-250			BOR-R/11-400-200	498,52 €
400-280	GF-753901016	1 085,26 €		
400-315	GF-753901017	1 018,60 €	BOR-R/11-400-315	714,78 €
400-355	GF-753901018	931,04 €		
450-400			BOR-R/11-450-400	563,42 €
500-400			BOR-R/11-500-400	762,30 €
500-450			BOR-R/11-500-450	762,30 €
560-400			BOR-R/11-560-400	1 022,78 €
560-450			BOR-R/11-560-450	1 037,08 €
560-500			BOR-R/11-560-500	922,24 €
630-400			BOR-R/11-630-400	1 322,86 €
630-450			BOR-R/11-630-450	1 311,64 €
630-500			BOR-R/11-630-500	1 271,82 €
630-560			BOR-R/11-630-560	1 225,40 €

GAZ WODA KANALIZACJA 

Injection reducer long PE100 SDR 17



GAS / WATER / SEWERS



WODA / SEWERS

d-d1	Code	Price Net	Code	Price Net
90-63	GF-753900872	12,54 €		
90-75	GF-753900870	12,54 €		
110-63	GF-753900877	16,94 €	BOR-R/17-110-63	9,90 €
110-75			BOR-R/17-110-75	9,90 €
110-90	GF-753900876	16,94 €	BOR-R/17-110-90	9,90 €
125-63	GF-753900882	17,82 €		
125-90	GF-753900881	19,58 €		
125-110	GF-753900880	19,58 €	BOR-R/17-125-110	10,12 €
140-75	GF-753900886	29,92 €		
140-90	GF-753900887	29,92 €		
140-110	GF-753900884	29,92 €		
140-125	GF-753900885	28,38 €	BOR-R/17-140-125	22,22 €
160-90	GF-753900888	38,06 €	BOR-R/17-160-90	15,40 €
160-110	GF-753900890	38,06 €	BOR-R/17-160-110	15,40 €
160-125	GF-753900889	38,06 €	BOR-R/17-160-125	19,80 €
160-140	GF-753900831	38,06 €	BOR-R/17-160-140	19,80 €
180-90	GF-753900873	44,44 €	BOR-R/17-180-90	29,04 €
180-110	GF-753900874	44,44 €	BOR-R/17-180-110	29,04 €
180-125	GF-753900891	48,40 €	BOR-R/17-180-125	40,70 €
180-140	GF-753900875	48,40 €	BOR-R/17-180-140	40,70 €
180-160	GF-753900832	46,20 €	BOR-R/17-180-160	40,70 €
200-140	GF-753900866	56,54 €	BOR-R/17-200-140	40,70 €
200-160	GF-753900892	53,68 €	BOR-R/17-200-160	40,70 €
200-180	GF-753900893	53,68 €	BOR-R/17-200-180	40,70 €
225-110			BOR-R/17-225-110	66,88 €
225-125			BOR-R/17-225-125	66,88 €
225-140	GF-753900867	90,42 €	BOR-R/17-225-140	66,88 €
225-160	GF-753900896	86,46 €	BOR-R/17-225-160	66,88 €
225-180	GF-753900895	86,46 €	BOR-R/17-225-180	66,88 €
225-200	GF-753900894	86,46 €	BOR-R/17-225-200	61,38 €
250-160	GF-753900800	124,96 €	BOR-R/17-250-160	69,74 €
250-180	GF-753900868	140,80 €		
250-200	GF-753900801	124,96 €	BOR-R/17-250-200	69,74 €
250-225	GF-753900802	124,96 €	BOR-R/17-250-225	83,60 €
280-200	GF-753900898	176,66 €	BOR-R/17-280-200	106,26 €
280-225	GF-753900899	176,66 €	BOR-R/17-280-225	112,86 €
280-250	GF-753900803	145,64 €	BOR-R/17-280-250	123,86 €
315-160			BOR-R/17-315-160	176,22 €
315-200			BOR-R/17-315-200	141,90 €
315-225	GF-753900807	145,64 €	BOR-R/17-315-225	141,90 €
315-250	GF-753900805	145,64 €	BOR-R/17-315-250	141,90 €
315-280	GF-753900806	145,64 €	BOR-R/17-315-280	176,22 €
355-200			BOR-R/17-355-200	373,56 €
355-250	GF-753900808	672,76 €	BOR-R/17-355-250	382,36 €
355-280	GF-753900809	624,14 €		
355-315	GF-753900810	628,76 €	BOR-R/17-355-315	470,80 €
400-200			BOR-R/17-400-200	448,80 €
400-280	GF-753900811	1 002,76 €		
400-315	GF-753900812	918,72 €	BOR-R/17-400-315	642,62 €
400-355	GF-753900813	880,44 €		
450-400			BOR-R/17-450-400	576,40 €
500-400			BOR-R/17-500-400	576,40 €
500-450			BOR-R/17-500-450	804,32 €
560-400			BOR-R/17-560-400	804,32 €
560-450			BOR-R/17-560-450	804,32 €
560-500			BOR-R/17-560-500	804,32 €
630-400			BOR-R/17-630-400	1 069,20 €
630-450			BOR-R/17-630-450	1 069,20 €
630-500			BOR-R/17-630-500	1 069,20 €
630-560			BOR-R/17-630-560	1 069,20 €

GAZ WODA KANALIZACJA 

Flange adaptor long PE100 SDR11

+GF+

GAS / WATER / SEWERS

TURAN (BORFIT)

WODA / SEWERS

d	Code	Price Net	Code	Price Net
20	GF-753800006	2,64 €		
25	GF-753800007	2,64 €		
32	GF-753800008	3,52 €		
40	GF-753800009	3,96 €		
50	GF-753800010	4,40 €		
63	GF-753800011	5,72 €	BOR-TL/11-063	4,84 €
75	GF-753800012	7,04 €	BOR-TL/11-075	5,50 €
90	GF-753800013	9,46 €	BOR-TL/11-090	7,04 €
110	GF-753800014	11,00 €	BOR-TL/11-110	8,58 €
125	GF-753800015	13,42 €	BOR-TL/11-125	10,56 €
140	GF-753800016	18,26 €	BOR-TL/11-140	16,50 €
160	GF-753800017	24,64 €	BOR-TL/11-160	21,56 €
180	GF-753800018	31,02 €	BOR-TL/11-180	28,38 €
200	GF-753800019	35,64 €	BOR-TL/11-200	33,66 €
225	GF-753800020	43,12 €	BOR-TL/11-225	41,58 €
250	GF-753800021	69,96 €	BOR-TL/11-250	61,38 €
280	GF-753800022	91,52 €	BOR-TL/11-280	78,10 €
315	GF-753800023	116,16 €	BOR-TL/11-315	101,20 €
355	GF-753800224	218,90 €	BOR-TL/11-355	154,22 €
400	GF-753800225	627,00 €	BOR-TL/11-400	301,40 €
450	GF-753800226	715,00 €	BOR-TL/11-450	445,06 €
500	GF-753800227	814,00 €	BOR-TL/11-500	519,42 €
560	GF-753800228	1 254,00 €	BOR-TL/11-560	764,50 €
630	GF-753800229	1 551,00 €	BOR-TL/11-630	816,64 €
710	GF-753800030	3 093,64 €		
800	GF-753800033	3 789,50 €		
900				
1000				



Flange adaptor long PE100 SDR17

+GF+

GAS / WATER / SEWERS

TURAN (BORFIT)

WODA / SEWERS

d	Code	Price Net	Code	Price Net
50	GF-753800085	4,18 €		
63	GF-753800086	4,62 €		
75	GF-753800087	6,60 €		
90	GF-753800088	8,58 €	BOR-TL/17-090	7,04 €
110	GF-753800089	10,34 €	BOR-TL/17-110	8,58 €
125	GF-753800090	12,76 €	BOR-TL/17-125	10,56 €
140	GF-753800091	17,16 €	BOR-TL/17-140	14,08 €
160	GF-753800092	18,92 €	BOR-TL/17-160	16,94 €
180	GF-753800093	29,48 €	BOR-TL/17-180	21,56 €
200	GF-753800094	33,22 €	BOR-TL/17-200	29,92 €
225	GF-753800095	35,86 €	BOR-TL/17-225	33,44 €
250	GF-753800096	54,12 €	BOR-TL/17-250	49,94 €
280	GF-753800097	82,06 €	BOR-TL/17-280	66,00 €
315	GF-753800098	108,02 €	BOR-TL/17-315	84,26 €
355	GF-753800299	204,60 €	BOR-TL/17-355	133,98 €
400	GF-753800300	305,80 €	BOR-TL/17-400	273,90 €
450	GF-753800301	671,00 €	BOR-TL/17-450	387,20 €
500	GF-753800302	682,00 €	BOR-TL/17-500	429,00 €
560	GF-753800303	792,00 €	BOR-TL/17-560	544,94 €
630	GF-753800304	950,40 €	BOR-TL/17-630	719,62 €
710	GF-753800105	2 572,24 €		
800	GF-753800106	3 101,78 €		
900	GF-753800107	on request		
1000	GF-753800108	on request		

GAZ WODA KANALIZACJA 

Steel flange PN16, PN10



PN16			PN10		
DN/d	Code	Price Net	Code	Price Net	
20/25	XK-ST-020/025	6,16 €	XK-ST-020/025	6,16 €	
25/32	XK-ST-025/032	6,82 €	XK-ST-025/032	6,82 €	
32/40	XK-ST-032/040	10,56 €	XK-ST-032/040	10,56 €	
40/50	XK-ST-040/050	12,76 €	XK-ST-040/050	12,76 €	
50/63	XK-ST-050/063	15,40 €	XK-ST-050/063	15,40 €	
65/75	XK-ST-065/075	16,94 €	XK-ST-065/075	16,94 €	
80/90	XK-ST-080/090	20,68 €	XK-ST-080/090	20,68 €	
100/110	XK-ST-100/110	23,54 €	XK-ST-100/110	23,54 €	
100/125	XK-ST-100/125	23,54 €	XK-ST-100/125	23,54 €	
125/125	XK-ST-125/125	33,00 €	XK-ST-125/125	33,00 €	
125/140	XK-ST-125/140	33,00 €	XK-ST-125/140	33,00 €	
150/160	XK-ST-150/160	35,42 €	XK-ST-150/160	35,42 €	
150/180	XK-ST-150/180	35,42 €	XK-ST-150/180	35,42 €	
200/200	XK-ST-200/200A	54,34 €	XK-ST-200/200	45,76 €	
200/225	XK-ST-200/225A	54,34 €	XK-ST-200/225	45,76 €	
250/250	XK-ST-250/250A	105,16 €	XK-ST-250/250	75,46 €	
250/280	XK-ST-250/280A	105,16 €	XK-ST-250/280	75,46 €	
300/315	XK-ST-300/315A	143,00 €	XK-ST-300/315	101,42 €	
350/355	XK-ST-350/355A	215,16 €	XK-ST-350/355	143,00 €	
400/400	XK-ST-400/400A	311,52 €	XK-ST-400/400	227,48 €	
450/450	XK-ST-450/450A	480,04 €	XK-ST-450/450	318,34 €	
500/450	XK-ST-500/450A	592,68 €	XK-ST-500/450	376,20 €	
500/500	XK-ST-500/500A	549,34 €	XK-ST-500/500	368,50 €	
600/560	XK-ST-600/560A	847,66 €	XK-ST-600/560	595,10 €	
600/630	XK-ST-600/600A	811,80 €	XK-ST-600/600	560,78 €	
700/710	XK-ST-700/710A	on request	XK-ST-700/710	773,08 €	
800/800	XK-ST-800/800A	on request	XK-ST-800/800	1 157,86 €	
900/900	XK-ST-900/900A	on request	XK-ST-900/900	1 408,66 €	
1000/1000	XK-ST-000/000A	on request	XK-ST-000/000	1 530,32 €	



PP/steel flange PN16, PN10



PN16			PN10		
DN/d	Code	Price Net	Code	Price Net	
20/25	GF-727700207	9,46 €	GF-727700207	9,46 €	
25/32	GF-727700208	11,88 €	GF-727700208	11,88 €	
32/40	GF-727700209	13,64 €	GF-727700209	13,64 €	
40/50	GF-727700210	17,16 €	GF-727700210	17,16 €	
50/63	GF-727700211	21,34 €	GF-727700211	21,34 €	
65/75	GF-727700212	23,54 €	GF-727700212	23,54 €	
80/90	GF-727700313	28,38 €	GF-727700313	28,38 €	
100/110	GF-727700314	34,54 €	GF-727700314	34,54 €	
100/125	GF-727700315	34,54 €	GF-727700315	34,54 €	
125/140	GF-727700716	40,92 €	GF-727700716	40,92 €	
150/160	GF-727700717	48,40 €	GF-727700717	48,40 €	
150/180	GF-727700718	60,06 €	GF-727700718	60,06 €	
200/200	GF-724700319	60,06 €	GF-727700719	60,06 €	
200/225	GF-724700320	on request	GF-727700720	87,12 €	
250/250	GF-724700321	on request	GF-727700721	110,44 €	
250/280	GF-724700322	on request	GF-727700722	110,44 €	
300/315	GF-724700323	on request	GF-727700723	161,04 €	
350/355	GF-724700324	on request	GF-727700724	319,44 €	
400/400	GF-724700325	on request	GF-727700725	363,44 €	
500/450			GF-724700426	on request	
500/500			GF-724700427	on request	
600/560			GF-724700428	on request	
600/630			GF-724700429	on request	

GAZ WODA KANALIZACJA 

Couplin type 3007 i 3000 WAGA Multi Joint PLUS

+GF+

d	Code	Code	Price Net
50	709 305 210	46-71	224,84 €
65	709 305 212	63-90	309,98 €
80	709 305 214	84-105	288,64 €
100	709 305 216	104-132	336,60 €
125	709 305 218	132-155	551,54 €
150	709 305 220	154-192	580,58 €
200	709 305 224	192-232	918,72 €
225	709 305 226	230-268	1 112,32 €
250	709 305 228	267-310	1 136,52 €
300	709 305 232	315-356	1 328,36 €
350	709 305 236	352-393	3 134,34 €
400	709 305 240	392-433	3 377,44 €
450	709 305 272	450-482	4 625,72 €
500	709 305 274	500-532	5 474,92 €
550	709 305 276	548-580	5 916,24 €
600	709 305 278	605-637	6 291,12 €



Coupling type 3057 i 3050 WAGA Multi Joint PLUS

+GF+

d	Code	Code	Price Net
50	709 355 210	DN 50 PN 16	191,84 €
65	709 355 212	DN 65 PN 16	247,94 €
80	709 355 214	DN 80 PN 16	271,92 €
100	709 355 216	DN 100 PN 16	324,94 €
125	709 355 218	DN 125 PN 16	507,76 €
150	709 355 220	DN 150 PN 16	474,54 €
200	709 355 224	DN 200 PN 10	711,92 €
200	709 355 225	DN 200 PN 16	779,68 €
250	709 355 228	DN 250 PN 10	909,48 €
250	709 355 229	DN 250 PN 16	976,14 €
300	709 355 232	DN 300 PN 10	1 119,80 €
300	709 355 233	DN 300 PN 16	1 178,98 €
350	709 355 236	DN 350 PN 10	2 434,74 €
350	709 355 237	DN 350 PN 16	2 559,92 €
400	709 355 238	DN 400 PN 10	2 644,62 €
400	709 355 239	DN 400 PN 16	2 771,34 €
500	709 355 274	DN 500 PN 10	3 743,30 €
600	709 355 278	DN 600 PN 10	5 695,80 €

GAZ WODA KANALIZACJA 